

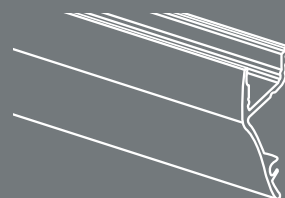

LINEA CONTINUA

2016

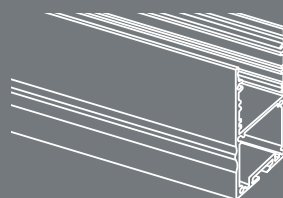
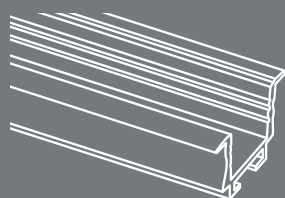
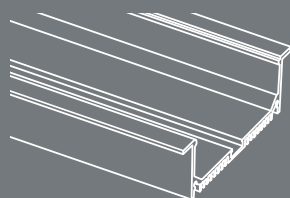

BINCOLOR

Le strip LED Dogi hanno un range stretto sulla colorazione della luce, garantendo una differenza di circa il 10% di tolleranza. La resina siliconica che viene utilizzata per garantire il grado di isolamento (IP), va ad alterare il Bicolor della strip, così come qualsiasi diffusore posto sopra ai profili di alluminio.

ANODIZZAZIONE

La maggior parte dei profili vengono anodizzati per evitare l'ossidazione dell'alluminio. L'anodizzazione è un processo chimico, pertanto ci potrebbero essere delle impurità dovute alla reazione dell'alluminio, questo non denota un difetto del prodotto ma una caratteristica tecnica. Il vantaggio di questo processo è la possibilità di verniciare con smalto il prodotto.

VERNICIATURA

Tutti i nostri profili W (bianco lucido RAL 9010) vengono verniciati a polvere con forno ad alta temperatura. È possibile verniciare anche con altre tinte RAL, con un piccolo costo aggiuntivo, chiedendo un preventivo e specificando il colore.

BINCOLOR

Dogi Led strips have a close range for color temperature, granting a maximum difference with a 10% tolerance. Color temperature is affected by silicon glue which is used for water insulation (IP) such as by any diffuser covering aluminum profiles.

ANODIZING

The major part of profiles are anodized in order to prevent aluminum oxidation. Anodizing is a chemical process, therefore there might be impurities caused by aluminum's reaction. This doesn't indicate a product defect but a technical feature. Advantage of this process is the possibility of paint the product with polishes.

PAINTING

All our profiles with code ending in "W" (Pure white RAL9010) are powder coated in high temperature ovens. It is possible to coat in other RAL colors, with a little additional cost, asking for a quotation and specifying the color.

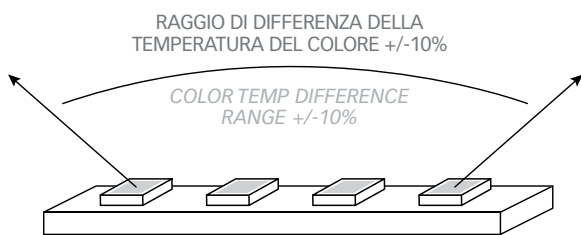

DITE DI NO ALLE DIFFERENZE DI COLORE!
Prima categoria, miglior qualità
SAY NO TO COLOR DIFFERENCE!
"A" series best quality

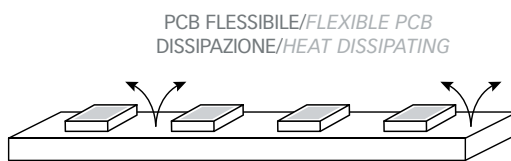

PCB più spesse, da 100g
Dissipazione del calore più rapida
Ottima per la durata di vita del LED
Thicker 4 ounces pcb
Heat dissipating faster
Excellent for led life time

5M PCB/5M PCB



PCB a strato singolo/Single layer PCB



PCB a strato doppio/Double layer PCB



PCB da 100g/4 ounces PCB

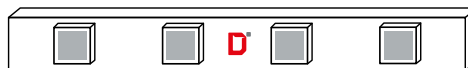

Logo riportato su ogni Strip LED
Logo printed on every LED strip

PCB E STRIP	Da pag. 04 a 12
ACCESSORI STRIP	Pag. 13
GESSI	Da pag. 16 a 17
PROFILI	Da pag. 18 a 89
INDICE APPLICATIVO	Da pag. 90 a 91
SENSOR TOUCH	Pag. 92
LA RESINATURA	Pag. 93
BARRA LED SU MISURA	Pag. 94
INFO TECNICHE (STRIP E ALIMENTATORI)	Pag. 95

INDICE GENERALE

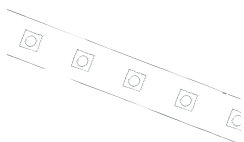

PCB201
pag. 04

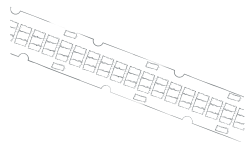

PCB202
pag. 05

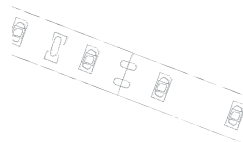

STP28
pag. 10

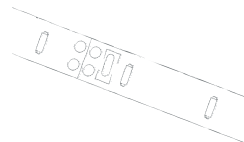

STP30
pag. 11

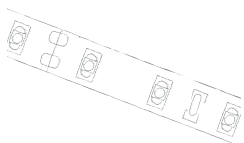

STP35
pag. 06

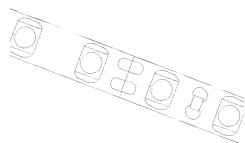

STP35/120S
pag. 07

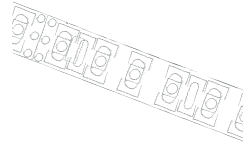

STP35/BI
pag. 12

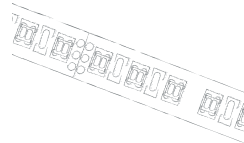

STP40/BI
pag. 12

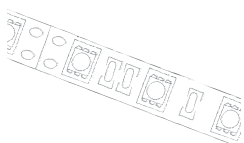

STP50
pag. 08

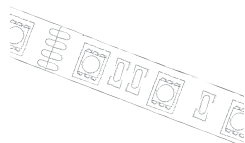

STP50/RGB
pag. 09

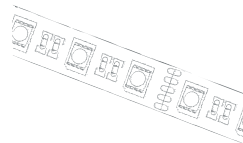

STP50/RGBW
pag. 09



INDICE STRIP

PCB201

Barra da 50cm con 30 LED sezionabile ogni 5cm.
PCB in alluminio 1,6mm.

50cm bar SMD (possible section every 5cm) on rigid PCB.
Aluminum PCB 1,6mm.



MODEL	Nr. LED/m	POWER SUPPLY	LENGHT TOT.	POWER
PCB201	60	24Vdc	50cm	20W
CODE	LED COLOR	CD/m	IP	
9800414110	 RGB	R 6300 mcd G 39000 mcd B 8100 mcd		

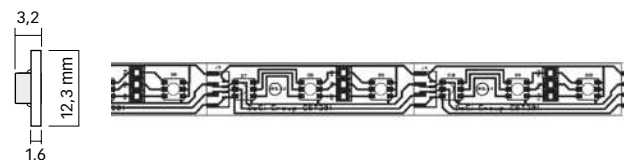
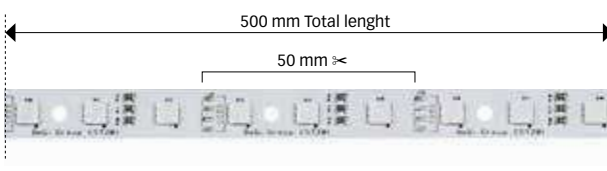

PCB202

Barra da 50cm con 120 LED sezionabile ogni 2,5cm.
PCB in alluminio 1,6mm.

50cm bar SMD (possible section every 2,5cm) on rigid PCB.
Aluminum PCB 1,6mm.



MODEL	Nr. LED/m	POWER SUPPLY	LENGHT TOT.	POWER
PCB202	120	24Vdc	50cm	7,5/15W
CODE	LED COLOR	LUMEN/m	IP	
9800414101	C 3000/3200K	2520lm	IP20	
9800414102	N 4000/4400K	2640lm		
9800414103	F 6000/6500K	2760lm		
9800414104	C 3000/3200K	6360lm	IP20	
9800414105	N 4000/4400K	6600lm		
9800414106	F 6000/6500K	6960lm		

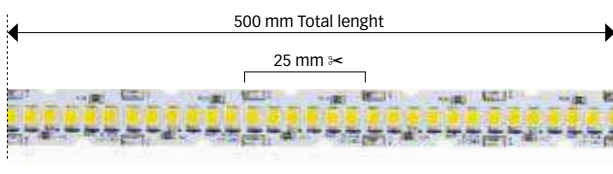

STP35

Striscia LED SMD 3528 da 5m (sezionabile ogni 2,5/5/10cm) su circuito stampato flessibile, fornita in bobina. IP64 e IP67 con resina siliconica.

5m strip LED SMD 3528 (possible section every 2,5/5/10cm) on flexible PCB. IP64 and IP67 with silicon cover.



MODEL	Nr. LED/m	POWER SUPPLY	LENGHT TOT.	LED	POWER/m
STP35	60	24Vdc	5m	3528	4,8W
CODE	LED COLOR	LUMEN/m	IP	LENS	
S206C324DX	C 3000/3200K	480lm	IP20	120°	
S206N324DX	N 4100/4400K	540lm			
S206F324DX	F 6000/6400K	600lm			
S646C324DX	C 3000/3200K	480lm	IP64	120°	
S646N324DX	N 4100/4400K	540lm			
S646F324DX	F 6000/6400K	600lm			
S676C324DX	C 3000/3200K	480lm	IP67	120°	
S676F324DX	F 6000/6400K	600lm			

MODEL	Nr. LED/m	POWER SUPPLY	LENGHT TOT.	LED	POWER/m
STP35/240	240	24Vdc	5m	3528	19,2W
CODE	LED COLOR	LUMEN/m	IP	LENS	
S240C324DX	C 3000/3200K	1920lm	IP20	120°	
S240N324DX	N 4100/4400K	2160lm			
S240F324DX	F 6000/6400K	2400lm			

MODEL	Nr. LED/m	POWER SUPPLY	LENGHT TOT.	LED	POWER/m
STP35/120	120	24Vdc	5m	3528	9,6W
CODE	LED COLOR	LUMEN/m	IP	LENS	
S200C324DX	C 3000/3200K	960lm	IP20	120°	
S200N324DX	N 4100/4400K	1080lm			
S200F324DX	F 6000/6400K	1200lm			
S640C324DX	C 3000/3200K	960lm	IP64	120°	
S640N324DX	N 4100/4400K	1080lm			
S640F324DX	F 6000/6400K	1200lm			
S670C324DX	C 3000/3200K	960lm	IP67	120°	
S670F324DX	F 6000/6400K	1200lm			

Accessori non inclusi/Accessories not included

ALIMENTATORI/POWER SUPPLY

	STP35	STP35/120	STP35/240
IP20 - IP64			
1 m	APT006.24	APT015.24	APT030.24
2 m	APT015.24	APT030.24	APT060.24
3 m	APT015.24	APT030.24	APT060.24
4 m	APT030.24	APT060.24	ALT100.24
5 m	APT030.24	APT060.24	ALT100.24
IP67			
1 m	APP009.24	ALP015.24	
2 m	ALP015.24	ALP030.24	
3 m	ALP015.24	ALP030.24	
4 m	ALP030.24	ALP060.24	
5 m	ALP030.24	ALP060.24	

DIMMER: AMP101 - CTR110 - AL288W

STP35/120S

Striscia LED SMD 3528 da 5mm ultrasottile (sezionabile ogni 5cm) su circuito stampato flessibile, fornita in bobina da 5m. Adatta per effettuare decorazioni tramite i profili PRF017 e PRF037.

Ultra slim 5mm SMD3528 LED strip (possible section every 5cm) on flexible PCB, provided in 5m reel. Suitable to realize decoration with profiles series PRF017 and PRF037.



MODEL	Nr. LED/m	POWER SUPPLY	LENGHT TOT.	LED	POWER/m
STP35	120	24Vdc	5m	3528	9,6W
CODE	LED COLOR	LUMEN/m	IP	LENS	
S205C324DX	C 3000/3200K	960lm	IP20	120°	
S205N324DX	N 4000/4400K	1080lm			
S205F324DX	F 6000/6500K	1200lm			

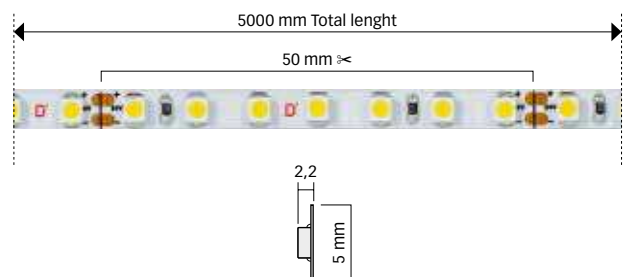

Accessori non inclusi/Accessories not included

ALIMENTATORI/POWER SUPPLY

STP35/120

IP20 - IP64

1 m	APT015.24
2 m	APT030.24
3 m	APT030.24
4 m	APT060.24
5 m	APT060.24

DIMMER: AMP101 - CTR110

STP50

Striscia LED SMD 5050 da 5m (sezionabile ogni 10cm) su circuito stampato flessibile, fornita in bobina. IP64 e IP67 con resina siliconica.

5m strip LED SMD 5050 (possible section every 10cm) on flexible PCB. IP64 and IP67 with silicon cover.



MODEL	Nr. LED/m	POWER SUPPLY	LENGHT TOT.	LED	POWER/m
STP50	60	24Vdc	5m	5050	14,4W

CODE	LED COLOR	LUMEN/m	IP	LENS
S206C524DX	C 3000/3200K	1440lm	IP20	120°
S206N524DX	N 4100/4400K	1500lm		
S206F524DX	F 6000/6400K	1560lm		
S646C524DX	C 3000/3200K	1440lm	IP64	120°
S646N524DX	N 4100/4400K	1500lm		
S646F524DX	F 6000/6400K	1560lm		

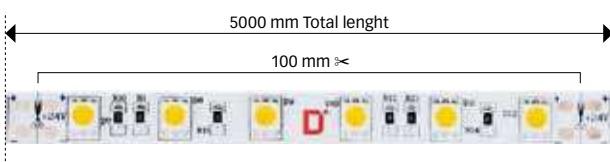

CODE	LED COLOR	LUMEN/m	IP	LENS
S676C524DX	C 3000/3200K	1200lm	IP67	120°
S676F524DX	F 6000/6400K	1320lm		

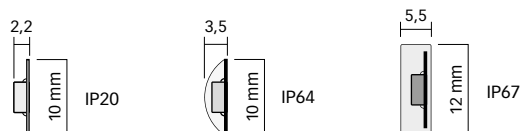
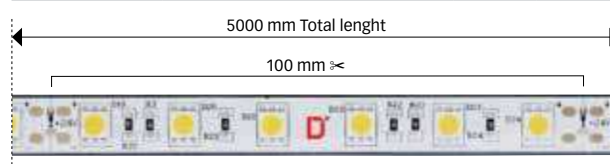

Accessori non inclusi/Accessories not included

ALIMENTATORI/POWER SUPPLY

STP50

	IP20 - IP64	IP67
1 m	APT015.24	ALP015.24
2 m	APT030.24	ALP030.24
3 m	APT060.24	ALP060.24
4 m	APT060.24	ALP030.24
5 m	ALT100.24	ALP120.24

DIMMER: AMP**101** - CTR**110**

STP50/RGB

Striscia LED SMD 5050 da 5m (sezionabile ogni 10cm) su circuito stampato flessibile, fornita in bobina. IP64 e IP67 con resina siliconica.

5m strip LED SMD 5050 (possible section every 10cm) on flexible PCB. IP64 and IP67 with silicon cover.

STP50/RGBW

Striscia LED SMD 5050 da 5m (sezionabile ogni 10cm) su circuito stampato flessibile, fornita in bobina. Oltre ai tre canali RGB (Rosso, Verde, Blu) in questa striscia è presente anche una sezione di LED Bianco Caldo.

In addition to the three RGB channels (Red, Green and Blue), on this stripe there is also a cold white LED section. 5m strip LED SMD 5050 (possible section every 10cm) on flexible PCB.



MODEL	Nr. LED/m	POWER SUPPLY	LENGHT TOT.	LED	POWER/m
STP50/RGB	60	24Vdc	5m	5050	14,4W
CODE	LED COLOR	CD/m	IP	LENS	
S206X2RGBX	RGB	138cd	IP20	120°	
S646X2RGBX	RGB	138cd	IP64	120°	
S676X2RGBX	RGB	138cd	IP67	120°	

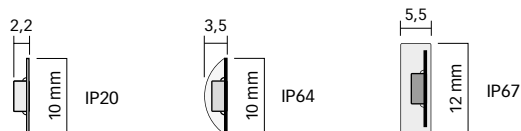
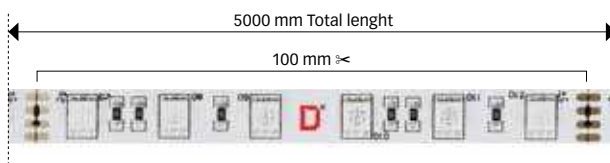

Accessori non inclusi/Accessories not included

ALIMENTATORI/POWER SUPPLY

STP50/RGB

	IP20 - IP64	IP67
1 m	APT015.24	ALP015.24
2 m	APT030.24	ALP030.24
3 m	APT060.24	ALP060.24
4 m	APT060.24	ALP060.24
5 m	ALT100.24	ALP120.24

CONTROLLER: AMP100 - CTR001 - CTR100S - CTR202 - CTR212

MODEL	Nr. LED/m	POWER SUPPLY	LENGHT TOT.	LED	POWER/m
STP50/RGBW	60	24Vdc	5m	5050	19,2W
CODE	LED COLOR	LUMEN/m	IP	LENS	
S206C2RGBW	RGBW	480lm	IP20	120°	

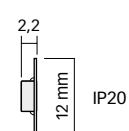
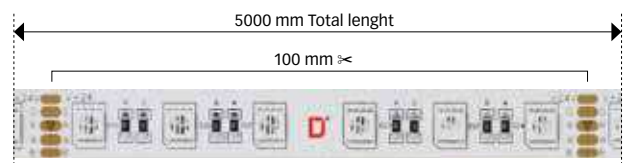

Accessori non inclusi/Accessories not included

ALIMENTATORI/POWER SUPPLY

STP50/RGBW

	IP20
1 m	APT030.24
2 m	APT060.24
3 m	APT060.24
4 m	APT100.24
5 m	APT100.24

CONTROLLER: CTR213 - CTR203 - CTR420

STP28

Striscia LED SMD 2835 da 5m (sezionabile ogni 2,5/5cm) su circuito stampato flessibile, fornita in bobina. IP64 con resina siliconica.

5m strip LED SMD 2835 (possible section every 2,5/5cm) on flexible PCB. IP64 with silicon cover.



MODEL	Nr. LED/m	POWER SUPPLY	LENGHT TOT.	LED	POWER/m
STP28	60	24Vdc	5m	2835	12W
CODE	LED COLOR	LUMEN/m	IP	LENS	
S206C224DX	C 3000/3200K	1320lm	IP20	120°	
S206N224DX	N 4100/4400K	1380lm			
S206F224DX	F 6000/6400K	1440lm			
S646C224DX	C 3000/3200K	1320lm	IP64	120°	
S646N224DX	N 4100/4400K	1380lm			
S646F224DX	F 6000/6400K	1440lm			

MODEL	Nr. LED/m	POWER SUPPLY	LENGHT TOT.	LED	POWER/m
STP28/120	120	24Vdc	5m	2835	24W
CODE	LED COLOR	LUMEN/m	IP	LENS	
S200C224DX	C 3000/3200K	2640lm	IP20	120°	
S200N224DX	N 4100/4400K	2760lm			
S200F224DX	F 6000/6400K	2880lm			
S640C224DX	C 3000/3200K	2640lm	IP64	120°	
S640N224DX	N 4100/4400K	2760lm			
S640F224DX	F 6000/6400K	2880lm			

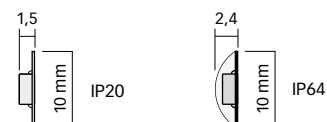
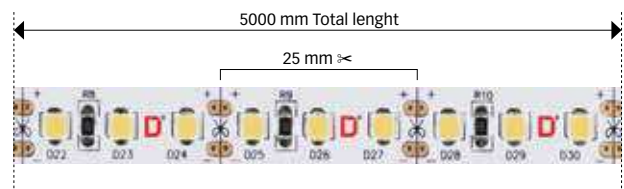
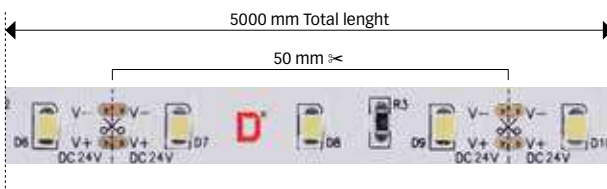

Accessori non inclusi / Accessories not included

ALIMENTATORI/POWER SUPPLY

	STP28	STP28/120
IP20 - IP64		
1 m	APT015.24	APT030.24
2 m	APT030.24	APT060.24
3 m	APT060.24	ALT100.24
4 m	APT060.24	ALT100.24
5 m	APT060.24	ALT150.24

DIMMER: AMP101 - CTR110

STP30

Striscia LED SMD 3014 da 5m (sezionabile ogni 2,5/5cm) su circuito stampato flessibile, fornita in bobina. IP64 con resina siliconica.

5m strip LED SMD 3014 (possible section every 2,5/5cm) on flexible PCB. IP64 with silicon cover.



MODEL	Nr. LED/m	POWER SUPPLY	LENGHT TOT.	LED	POWER/m
STP30	60	24Vdc	5m	3014	6W

CODE	LED COLOR	LUMEN/m	IP	LENS
S206C314DX	C 3000/3200K	660lm	IP20	120°
S206N314DX	N 4100/4400K	720lm		
S206F314DX	F 6000/6400K	780lm		
S646C314DX	C 3000/3200K	660lm	IP64	120°
S646N314DX	N 4100/4400K	720lm		
S646F314DX	F 6000/6400K	780lm		

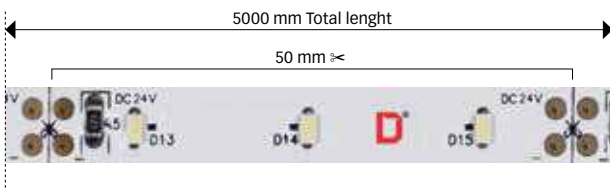

MODEL	Nr. LED/m	POWER SUPPLY	LENGHT TOT.	LED	POWER/m
STP30/120	120	24Vdc	5m	3014	12W

CODE	LED COLOR	LUMEN/m	IP	LENS
S200C314DX	C 3000/3200K	1320lm	IP20	120°
S200N314DX	N 4100/4400K	1440lm		
S200F314DX	F 6000/6400K	1560lm		
S640C314DX	C 3000/3200K	1320lm	IP64	120°
S640N314DX	N 4100/4400K	1440lm		
S640F314DX	F 6000/6400K	1560lm		

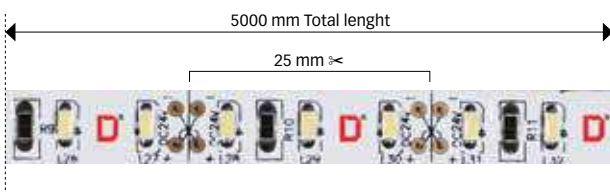

MODEL	Nr. LED/m	POWER SUPPLY	LENGHT TOT.	LED	POWER/m
STP30/240	240	24Vdc	5m	3014	24W

CODE	LED COLOR	LUMEN/m	IP	LENS
S240C314DX	C 3000/3200K	2640lm	IP20	120°
S240N314DX	N 4100/4400K	2880lm		
S240F314DX	F 6000/6400K	3120lm		

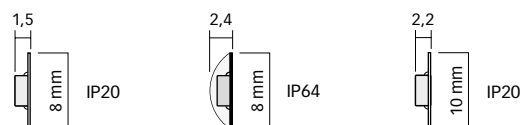
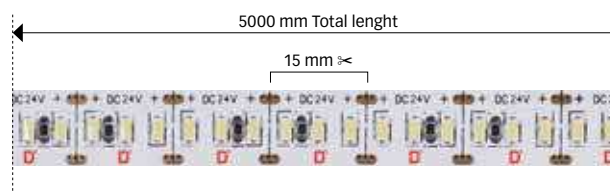

Accessori non inclusi / Accessories not included

ALIMENTATORI/POWER SUPPLY

	STP30	STP30/120	STP30/240
IP20 - IP64			
1 m	APT009.24	APT015.24	APT030.24
2 m	APT015.24	APT030.24	APT060.24
3 m	APT030.24	APT060.24	ALT100.24
4 m	APT030.24	APT060.24	ALT100.24
5 m	APT060.24	APT060.24	ALT150.24

DIMMER: AMP101 - CTR110

STP35/BI

Striscia LED SMD 3528 da 5m (sezionabile ogni 10cm) su circuito stampato flessibile sigillato, fornita in bobina. LED alternati (calda/fredda) per regolare la temperatura colore. 5m strip Led SMD 3528 (possible section every 10cm) on flexible PCB sealed. LED alternate (warm/cold) to adjust the color temperature.

STP40/BI

Striscia LED SMD 4014 da 5m (sezionabile ogni 5cm) su circuito stampato flessibile sigillato, fornita in bobina. LED integrati (calda/fredda) per regolare la temperatura colore. 5m strip Led SMD 4014 (possible section every 5cm) on flexible PCB sealed. LED fullwhite (warm/cold) to adjust the color temperature.



MODEL	Nr. LED/m	POWER SUPPLY	LENGHT TOT.	LED	POWER/m	CRI
STP35/BI	120	24Vdc	5m	3528	9,6W	>70

CODE	LED COLOR	LUMEN/m	IP	LENS
S200K324DX	2700/6500K	540/700lm	IP20	120°

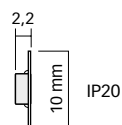

Accessori non inclusi / Accessories not included

ALIMENTATORI/POWER SUPPLY

STP35/BI

IP20	
1 m	APT015.24
2 m	APT030.24
3 m	APT030.24
4 m	APT060.24
5 m	APT060.24

DIMMER: AMP101 - CTR111

MODEL	Nr. LED/m	POWER SUPPLY	LENGHT TOT.	LED	POWER/m	CRI
STP40/BI	120	24Vdc	5m	4014	19,2W	>90

CODE	LED COLOR	LUMEN/m	IP	LENS
S200X324DX	2700/6500K	650/850lm	IP20	120°

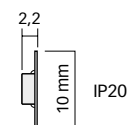

Accessori non inclusi / Accessories not included

ALIMENTATORI/POWER SUPPLY

STP40/BI

IP20	
1 m	APT030.24
2 m	APT060.24
3 m	APT060.24
4 m	ALT100.24
5 m	ALT100.24

DIMMER: AMP101 - CTR111

ACCESSORI STRIP

Serie di accessori per strip Led.

Range of accessories for Led series.

CODE VCCONN0004
Connettore di collegamento
4 PIN (RGB), 10 mm.
4 PIN (RGB) Link connector, 10 mm.



CODE VCCONN0008
per strip 8 mm/for 8 mm strip
CODE VCCONN0002
per strip 10 mm/for 10 mm strip
Connettore di collegamento 2 PIN. 2 PIN Link connector.



CODE VCCONN0003
Coppia di connettori RGB
per connessione IP65.
*Couple of RGB connectors,
for IP65 connection.*



CODE VCCONN0001
Coppia di connettori
per connessione IP65.
*Couple of connectors,
for IP65 connection.*



CODE VCCONN0014
Connettore di collegamento 4 PIN (RGB) 10 mm, cavo 15 cm.
4 PIN (RGB) Link connector 10 mm, 15 cm cable.



CODE VCCONN0018 - per strip 8 mm/for 8 mm strip
CODE VCCONN0012 - per strip 10 mm/for 10 mm strip
Connettore di collegamento 2 PIN, cavo 15 cm.
2 PIN Link connector 15 cm cable.

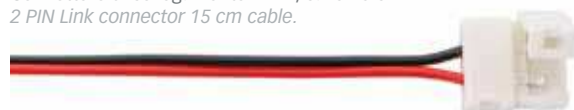

CODE VCCONN0024
Connettore di collegamento 4 PIN (RGB) 4 PIN 10 mm, cavo 15 cm.
4 PIN (RGB) 4 PIN Link connector 10 mm, 15 cm cable.



CODE VCCONN0028 - per strip 8 mm/for 8 mm strip
CODE VCCONN0022 - per strip 10 mm/for 10 mm strip
Connettore di collegamento 2 PIN (RGB) - 2 PIN cavo 15 cm.
2 PIN (RGB) - 2 PIN Link connector 15 cm cable.



CODE VTAPPO0010
Tappo di chiusura 10 mm.
10 mm closing plug.



CODE VTAPPO0012
Tappo di chiusura 12 mm.
12 mm closing plug.



CODE VTAPPO0014
Tappo di chiusura 14 mm.
14 mm closing plug.



CODE VFFISS0010
Fascette di fissaggio 10 mm.
10 mm fixing clip.



CODE VFFISS0012
Fascette di fissaggio 12 mm.
12 mm fixing clip.



CODE VFFISS0014
Fascette di fissaggio 14 mm.
14 mm fixing clip.



CODE VCCONN0005
Cavo per strip e centraline
RGB dotato di connettore.
*RGB cable for RGB strips
and controllers equipped
with connector.*



CODE VSILTUBE01
Tubetto di silicone
per isolamento.
Silicon tube as insulation.



ACCESSORI STRIP

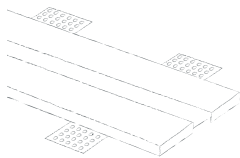

GS030 series

pag. 16

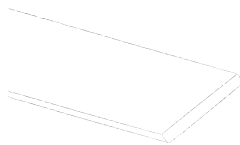

PRF002

pag. 18

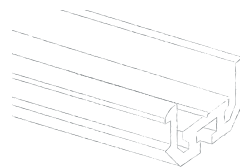

PRF003

pag. 30

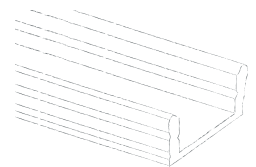

PRF004

pag. 32

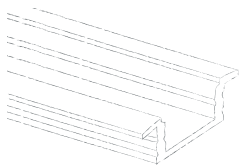

PRF005

pag. 42

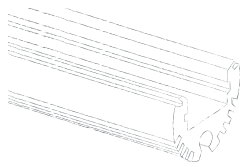

PRF006

pag. 68

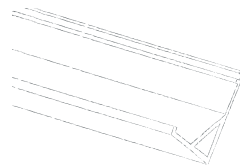

PRF007

pag. 56

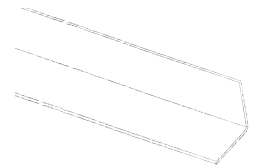

PRF008

pag. 20

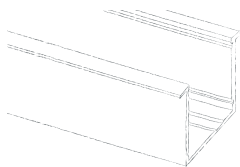

PRF009

pag. 48

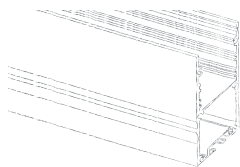

PRF010

pag. 70

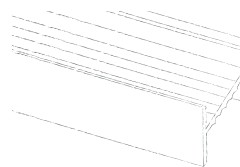

PRF011

pag. 34

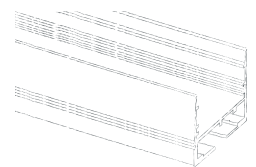

PRF012

pag. 38

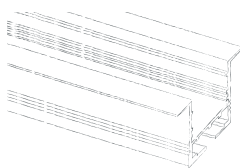

PRF013

pag. 46

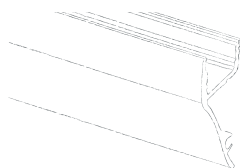

PRF014

pag. 62

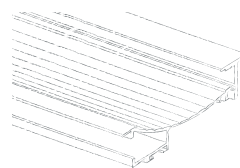

PRF015

pag. 74

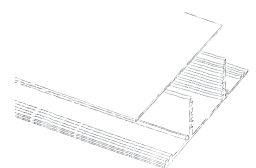

PRF016

pag. 66

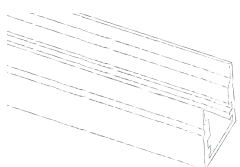

PRF017

pag. 26

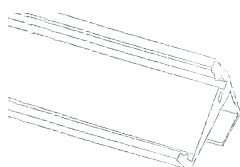

PRF018/019

pag. 76

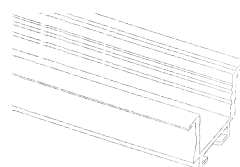

PRF020

pag. 44

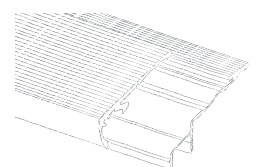

PRF021

pag. 80



PRF022

pag. 72

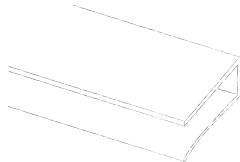

PRF023

pag. 78

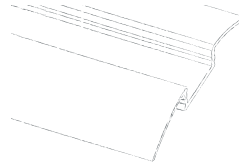

PRF024

pag. 84

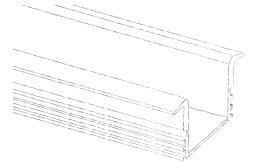

PRF025

pag. 86

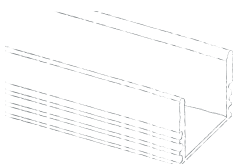

PRF026

pag. 88

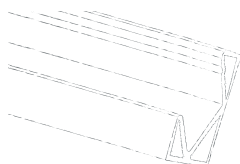

PRF027

pag. 58

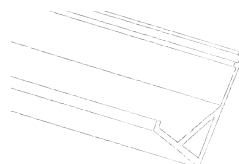

PRF028

pag. 60

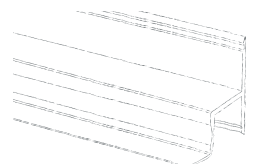

PRF029

pag. 24

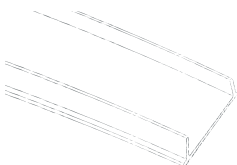

PRF030

pag. 22

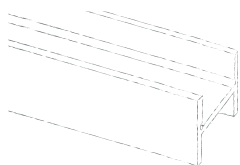

PRF031

pag. 36

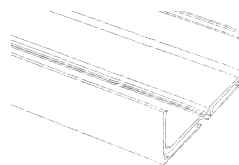

PRF032

pag. 40

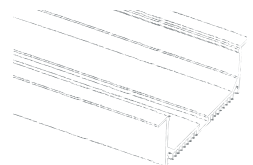

PRF033

pag. 54

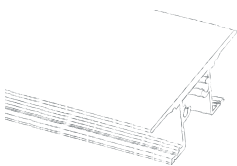

PRF034

pag. 64

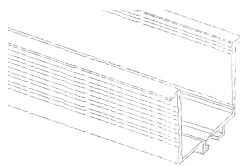

PRF035

pag. 50

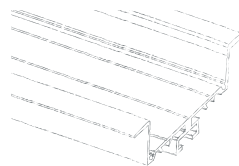

PRF036

pag. 52

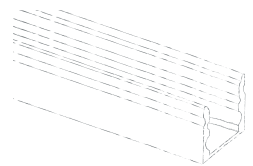

PRF037

pag. 28



PRF038

pag. 82

GS030 series

Struttura da incasso in gesso per interni, riproduce una striscia continua luminosa a LED, completamente invisibile. Disponibile in tre diverse lunghezze e con le intersezioni ad L e T si possono comporre numerose forme geometriche. Il diffusore viene fornito separatamente in barre da 2m.

Recessed indoor chalk structure, it creates a continuous LED luminous light, completely invisible. Available in three different lengths and with L and T joints various geometrical shapes can be composed. Diffuser is supplied separately in 2m bars.

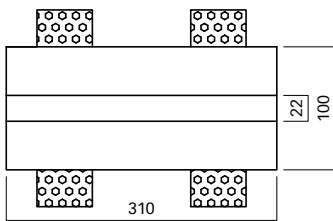
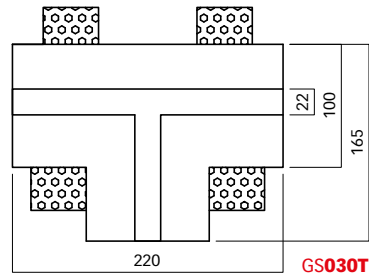
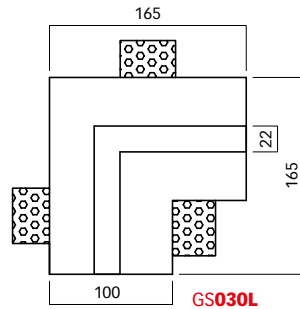

GS030/031

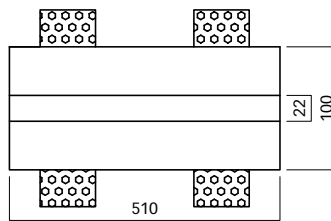

GS030/051

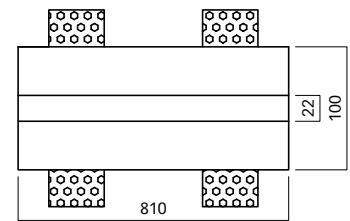

GS030/081

CODE	DESCRIPTION
GS030L	Angolo a L/L shaped corner
GS030T	Giuntura a T/T shaped joint
GS030/031	Lunghezza 31cm/31cm long
GS030/051	Lunghezza 51cm/51cm long
GS030/081	Lunghezza 81cm/81cm long
GS030PX03	Diffusore opale, barra 2m/Opal diffuser, bar length 2m

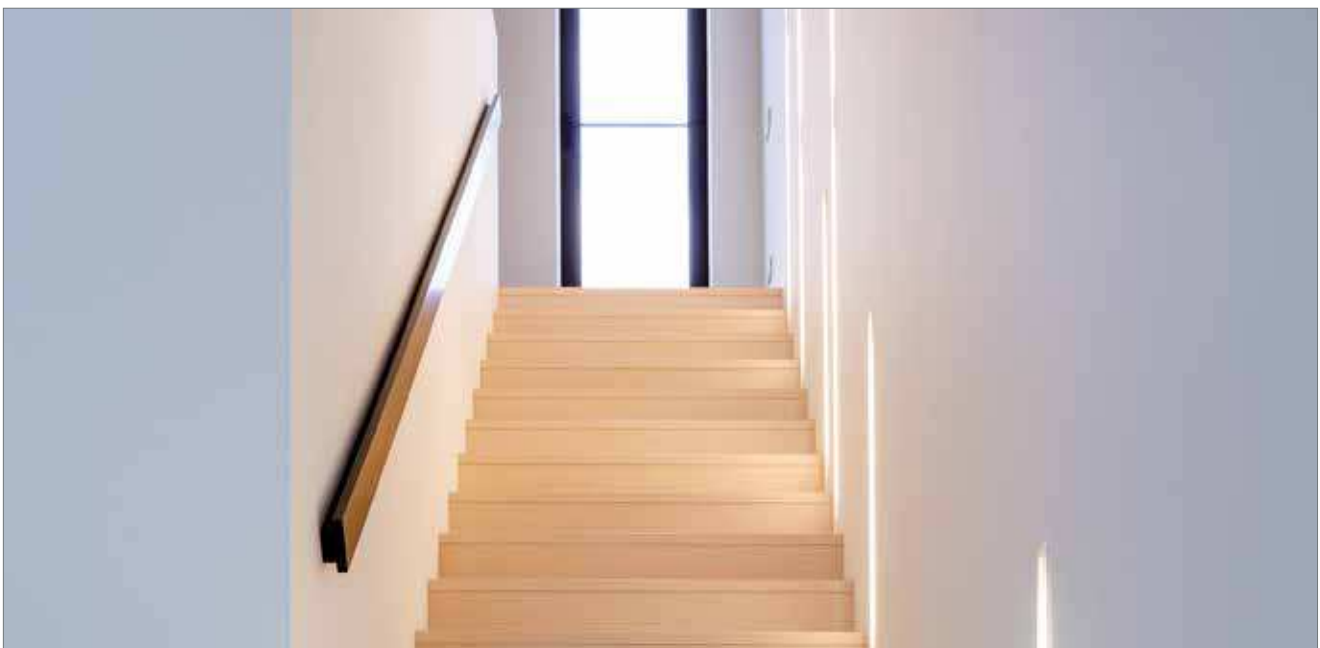

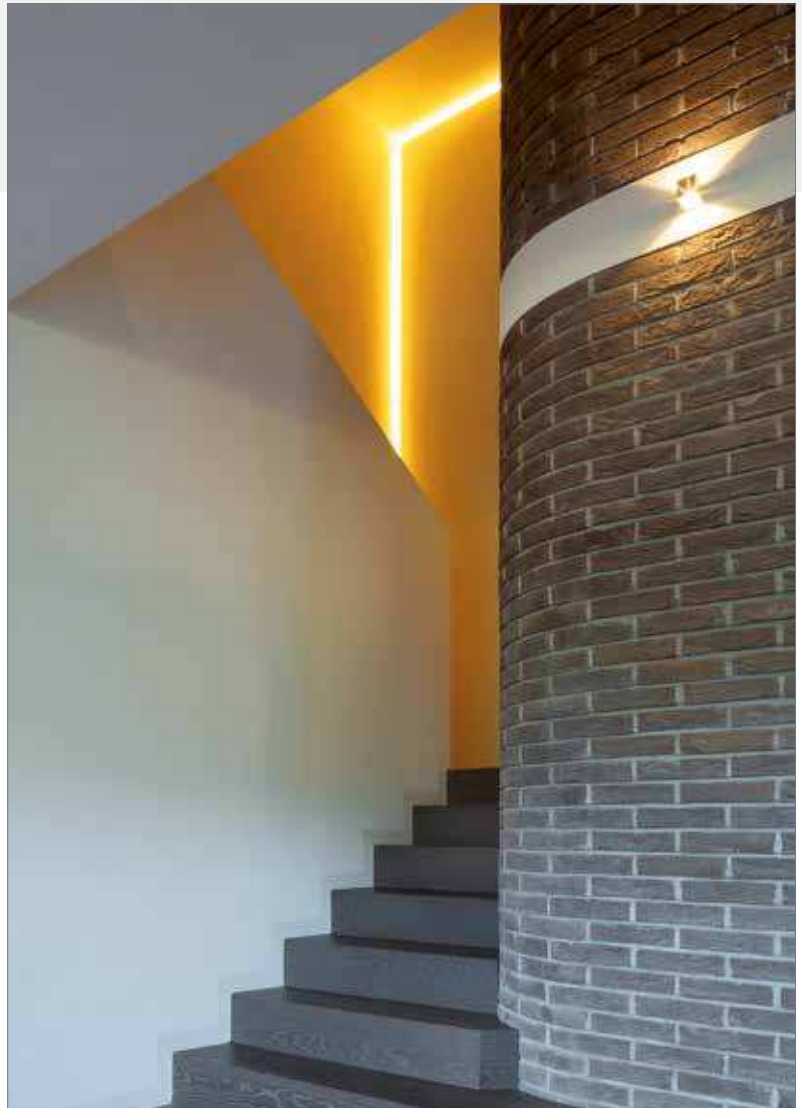

GS030L



GS030T

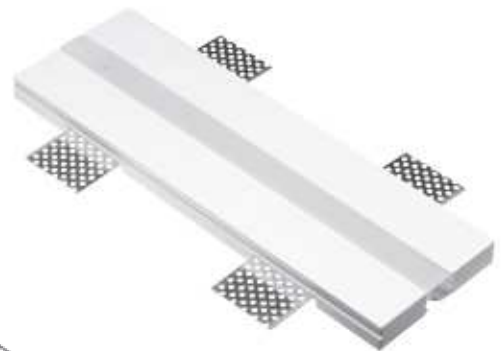

GS030/031 - GS030/051 - GS030/081

GS030 series

PRF002

Piattina in alluminio estruso anodizzata. Sistema economico per il raffreddamento delle strisce LED. Il prodotto si presta per essere personalizzato, dal colore del profilo alla lunghezza, potendosi scegliere il tipo di illuminazione che desideriamo.

Anodized extruded aluminum flat profile. Cheaper solution for LED strips cooling. Product is suitable for customization, from its color to its length, making it possible to choose the type of illumination you need.

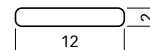
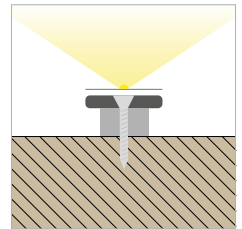
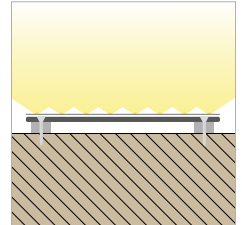

CODE	DESCRIPTION
PRF002/200	Profilo in alluminio piatto, barra 2m/Flat aluminum profile, bar length 2m





PRF002

PRF008

Profilo in alluminio estruso anodizzato angolare, ideale per l'installazione sottopensile con rifrazione della luce all'interno. Il prodotto si presta per essere personalizzato, dal colore del profilo alla lunghezza, potendo scegliere il tipo di illuminazione che desideriamo.

Anodized extruded aluminum angular profile. Suitable for under cabinet installation for internal light refraction. Product is suitable for customization, from its color to its length, making it possible to choose the type of illumination you need.

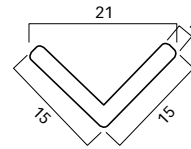

PRF008

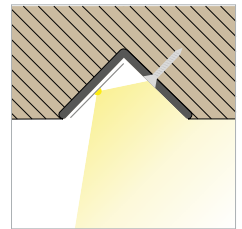

CODE	DESCRIPTION
PRF008/200	Profilo in alluminio ad angolo, barra 2m/Aluminum profile corner, bar lenght 2m





PRF008

PRF030

Profilo in alluminio estruso anodizzato flessibile, ideale per l'installazione su superfici curve a vista. Dato il suo spessore sottile, si adatta a delle curvature omogenee.

Extruded anodized flexible aluminum profile, suitable for installation on curved surfaces at sight. Due to its low thickness it easily fits homogeneous curvatures.

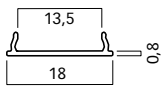

PRF030

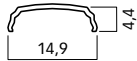

PX01/02



TP01

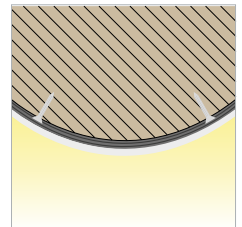
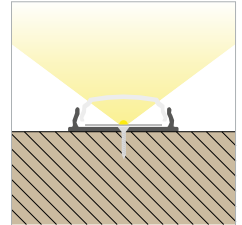

CODE	DESCRIPTION
PRF030/200	Profilo anodizzato flessibile, barra 2m/ <i>Flexible aluminum profile, bar lenght 2m</i>
PRF030PX01	Diffusore in PMMA opale, barra 2m/ <i>Opal PMMA diffuser, bar lenght 2m</i>
PRF030PX02	Diffusore in PMMA trasparente, barra 2m/ <i>Clear PMMA diffuser, bar lenght 2m</i>
PRF030TP01	Tappo per profilo serie 030/ <i>Cap for profile series 030</i>





PRF030

PRF029

Profilo in alluminio estruso anodizzato, ad incasso laterale.

Anodized extruded aluminum profile.

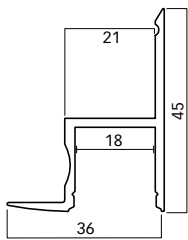

PRF029

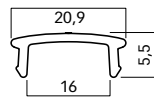

PX01

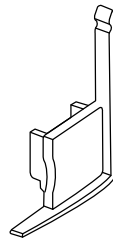

TP01

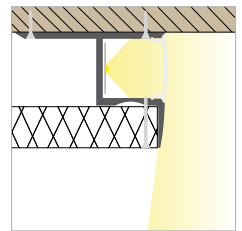
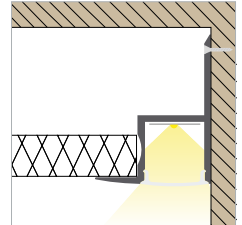

CODE	DESCRIPTION
PRF029/200	Profilo anodizzato, barra 2m/Aluminum profile, bar lenght 2m
PRF029PX01	Diffusore in PMMA opale, barra 2m/Opal PMMA diffuser, bar lenght 2m
PRF029TP01	Tappo per profilo serie 029/Cap for profile series 029





PRF029

PRF017

Profilo in alluminio estruso anodizzato ideale per l'installazione e raffreddamento delle strip a LED. Dimensioni compatte, da utilizzare con strip a barre LED da 5mm. Il prodotto si presta per essere personalizzato, dal colore del profilo alla lunghezza, potendo scegliere il tipo di illuminazione che desideriamo.

Anodized extruded aluminum profile. Suitable for installation and cooling of LED strips. Compact size, to be utilized with 5mm LED strips or bars. Product is suitable for customization, from its color to its length, making it possible to choose the type of illumination you need.

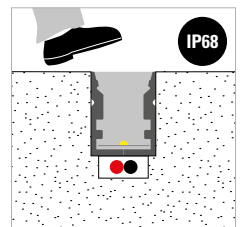
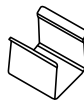
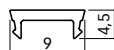
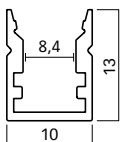
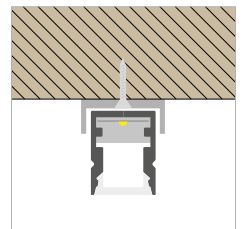
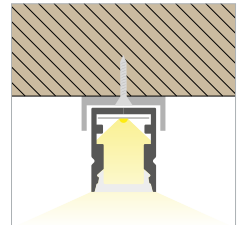

PRF017

PX01

ST01

TP01

CODE	DESCRIPTION
PRF017/200	Profilo in alluminio a U, barra 2m/Aluminum U profile, bar length 2m
PRF017PX01	Diffusore in PMMA opale, barra 2m/Opal PMMA diffuser, bar length 2m
PRF017ST01	Staffa per profilo serie 017/Clip for profile series 017
PRF017TP01	Tappo per profilo serie 017/Cap for profile series 017





PRF017

PRF037

Profilo in alluminio estruso anodizzato ideale per l'installazione e raffreddamento delle strip a LED. Dimensioni compatte, da utilizzare con strip a barre LED da 5mm. Il prodotto si presta per essere personalizzato, dal colore del profilo alla lunghezza, potendo scegliere il tipo di illuminazione che desideriamo.

Anodized extruded aluminum profile. Suitable for installation and cooling of LED strips. Compact size, to be utilized with 5mm LED strips or bars. Product is suitable for customization, from its color to its length, making it possible to choose the type of illumination you need.

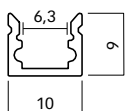
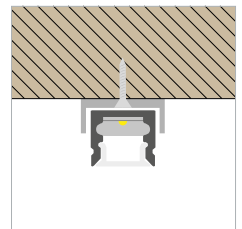
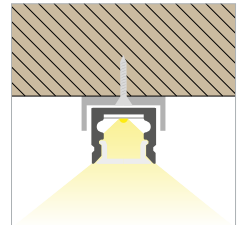

PRF037

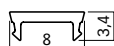

PX01

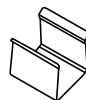

ST01



TP01

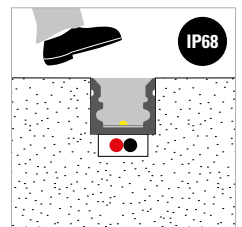

CODE	DESCRIPTION
PRF037/200	Profilo in alluminio a U, barra 2m/Aluminum U profile, bar length 2m
PRF037PX01	Diffusore in PMMA opale, barra 2m/Opal PMMA diffuser, bar length 2m
PRF037ST01	Staffa per profilo serie 037/Clip for profile series 037
PRF037TP01	Tappo per profilo serie 037/Cap for profile series 037





PRF037

PRF003

Profilo in alluminio estruso ideale per l'installazione e raffreddamento delle strip a LED. Universale per diverse applicazioni, con varie tipologie di diffusori. Il prodotto si presta per essere personalizzato, dal colore del profilo alla lunghezza, potendo scegliere il tipo di illuminazione che desideriamo.

Extruded aluminum profile suitable for installation and cooling of LED strips. Universal use for different applications, with various kind of diffusers. Product is suitable for customization, from its color to its length, making it possible to choose the type of illumination you need.

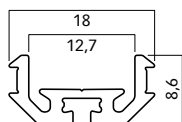
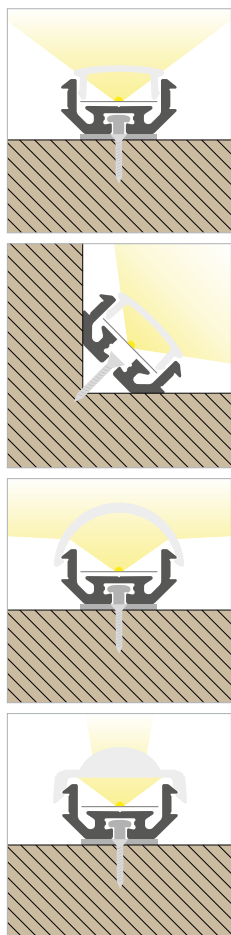

PRF003

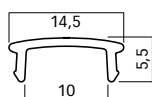

PX01/02/31/32

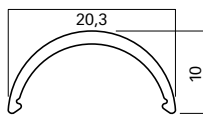

PX03/33

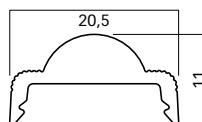

PX30

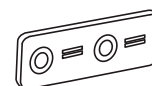

ST01

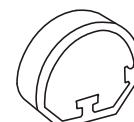

TP01

CODE	DESCRIPTION
PRF003/200	Profilo in alluminio a U, barra 2m/Aluminum U profile, bar length 2m
PRF003/300	Profilo in alluminio a U, barra 3m/Aluminum U profile, bar length 3m
PRF003PX01	Diffusore in PMMA opale, barra 2m/Opal PMMA diffuser, bar length 2m
PRF003PX31	Diffusore in PMMA opale, barra 3m/Opal PMMA diffuser, bar length 3m
PRF003PX02	Diffusore in PMMA trasparente, barra 2m/Clear PMMA diffuser, bar length 2m
PRF003PX32	Diffusore in PMMA trasparente, barra 3m/Clear PMMA diffuser, bar length 3m
PRF003PX03	Diffusore in PMMA satinato, barra 2m/Frosted PMMA diffuser, bar length 2m
PRF003PX33	Diffusore in PMMA satinato, barra 3m/Frosted PMMA diffuser, bar length 3m
PRF003PX30	Diffusore in PMMA, lente 30°, barra 2m/PMMA diffuser, lens 30°, bar length 2m
PRF003ST01	Staffa per profilo serie 003/Clip for profile series 003
PRF003TP01	Tappo per profilo serie 003 (solo per Px03)/Cap for profile series 003 (only for Px03)



PRF003

PRF004

Profilo in alluminio estruso anodizzato, ideale per l'installazione e raffreddamento delle strip a LED. Consigliato per l'installazione a luce indiretta (cartongesso). Il prodotto si presta per essere personalizzato, dal colore del profilo alla lunghezza, potendo scegliere il tipo di illuminazione che desideriamo.

Anodized extruded aluminum profile. Suitable for installation and cooling of LED strips. Recommended for the installation in indirect light (drywall). Product is suitable for customization, from its color to its length, making it possible to choose the type of illumination you need.

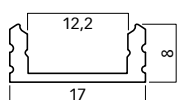
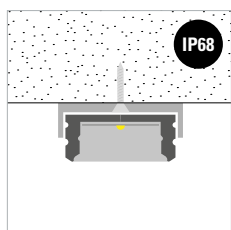
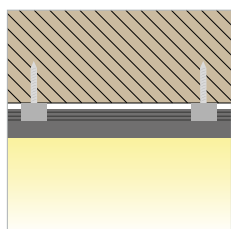
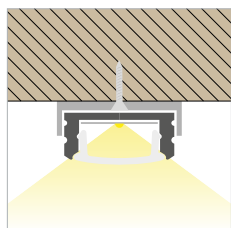

PRF004

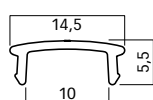

PX01/02

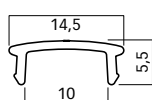

PX31/32

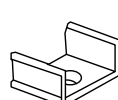

ST01

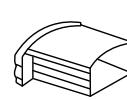

TP01

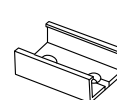

CL01

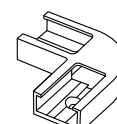

CN01

CODE	DESCRIPTION
PRF004/200	Profilo in alluminio, barra 2m/Aluminum profile, bar length 2m
PRF004/300	Profilo in alluminio, barra 3m/Aluminum profile, bar length 3m
PRF003PX01	Diffusore in PMMA opale, barra 2m/Opal PMMA diffuser, bar length 2m
PRF003PX31	Diffusore in PMMA opale, barra 3m/Opal PMMA diffuser, bar length 3m
PRF003PX02	Diffusore in PMMA trasparente, barra 2m/Clear PMMA diffuser, bar length 2m
PRF003PX32	Diffusore in PMMA trasparente, barra 3m/Clear PMMA diffuser, bar length 3m
PRF004ST01	Staffa per profilo serie 004/Clip for profile series 004
PRF004TP01	Tappo per profilo serie 004/Cap for profile series 004
PRF004CL01	Connettore lineare grigio/Linear connector gray
PRF004CN01	Connettore angolare grigio/Corner connector gray



PRF004

PRF011

Profilo in alluminio estruso anodizzato, ideale per l'installazione e raffreddamento delle strip a LED. Il diffusore quadrato permette l'uniformità della luce (senza vedere i punti LED). La staffa si aggancia all'interno del profilo rendendolo lineare. Il prodotto si presta per essere personalizzato, dal colore del profilo alla lunghezza, potendo scegliere il tipo di illuminazione che desideriamo.

Anodized extruded aluminum profile. Suitable for installation and cooling of LED strips. Squared diffuser allow unifor lighting (without seeing LEDs points). Brackets are fixed inside the profile making it linear. Product is suitable for customization, from its color to its lenght, making it possible to choose the type of illumination you need.

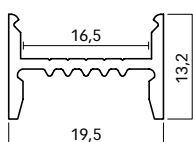
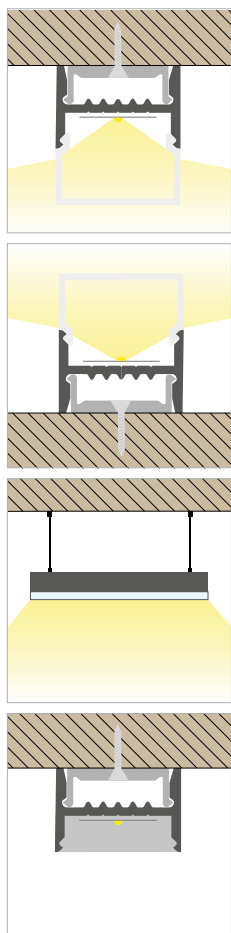

PRF011

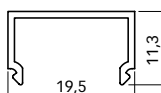

PX01/03

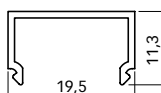

PX31/33

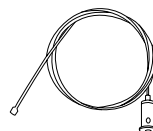

SSP002

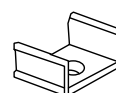

ST01



TP01

CODE	DESCRIPTION
PRF011/200	Profilo ad H in alluminio anodizzato, barra 2m/Aluminum profile, bar lenght 2m
PRF011/300	Profilo ad H in alluminio anodizzato, barra 3m/Aluminum profile, bar lenght 3m
PRF011PX01	Diffusore in PMMA opale, barra 2m/Opal PMMA diffuser, bar lenght 2m
PRF011PX31	Diffusore in PMMA opale, barra 3m/Opal PMMA diffuser, bar lenght 3m
PRF011PX05	Diffusore in PMMA bianco, barra 2m/Frosted PMMA diffuser, bar lenght 2m
PRF011PX35	Diffusore in PMMA bianco, barra 3m/Frosted PMMA diffuser, bar lenght 3m
PRF011ST01	Staffa per profilo serie 011/Clip for profile series 011
PRF011TP01	Tappo per profilo serie 011/Cap for profile series 011
SSP002	Kit sospensione con terminali lunghezza 1,5m/Suspension kit lenght 1,5m



PRF011

PRF031

Profilo in alluminio estruso anodizzato, ideale per essere incassato. Il diffusore copre la parte di profilo a vista. Il prodotto si presta per essere personalizzato, dal colore del profilo alla lunghezza, potendo scegliere il tipo di illuminazione che desideriamo.

Anodized extruded aluminum profile, designed for recessed installation. Diffuser covers the visible part of the profile. Product is suitable to be customized, from its color to its length, making it possible to choose the type of illumination you need.

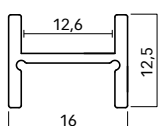
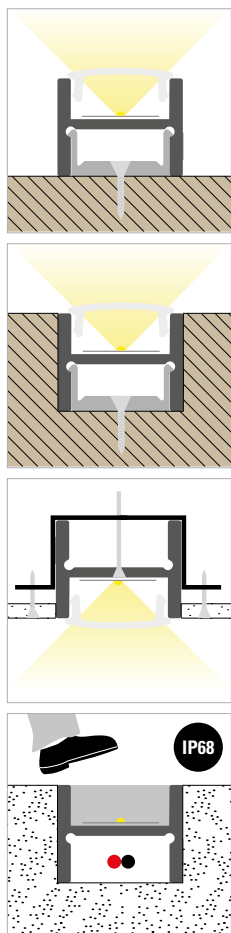

PRF031

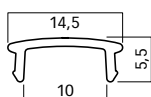

PX01/02

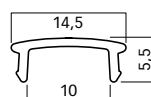

PX31/32

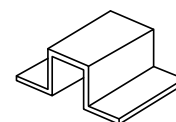

ST03

CODE	DESCRIPTION
PRF031/200	Profilo in alluminio a H, barra 2m/Aluminum H profile, bar lenght 2m
PRF031/300	Profilo in alluminio a H, barra 3m/Aluminum H profile, bar lenght 3m
PRF003PX01	Diffusore in PMMA opale, barra 2m/Opal PMMA diffuser, bar lenght 2m
PRF003PX31	Diffusore in PMMA opale, barra 3m/Opal PMMA diffuser, bar lenght 3m
PRF003PX02	Diffusore in PMMA trasparente, barra 2m/Clear PMMA diffuser, bar lenght 2m
PRF003PX32	Diffusore in PMMA trasparente, barra 3m/Clear PMMA diffuser, bar lenght 3m
PRF031ST03	Staffa per incasso filo cartongesso/Clip for recessed installation in drywalls



PRF031

PRF012

Profilo in alluminio estruso anodizzato da esterno. Con il kit dato come accessorio è possibile rendere a sospensione il prodotto. Adatto anche per strip LED IP67/68. Il prodotto si presta per essere personalizzato, dal colore del profilo alla lunghezza, potendo scegliere il tipo di illuminazione che desideriamo.

Outdoor anodized extruded aluminum profile. With the kit the profile can be suspended. Suitable also for IP67/IP68 LED strips. Product is suitable for customization, from its color to its length, making it possible to choose the type of illumination you need.

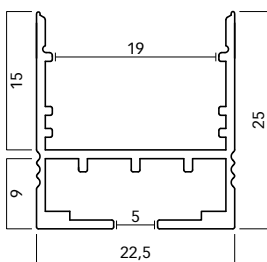
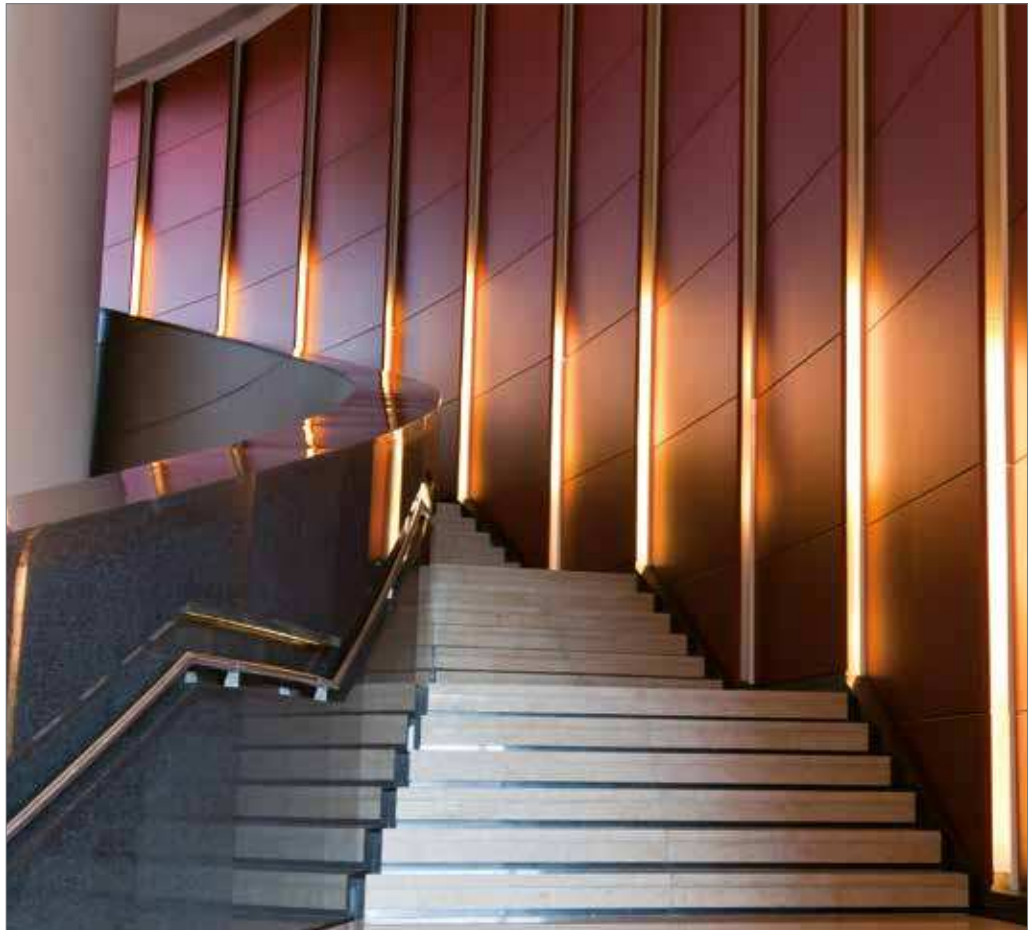
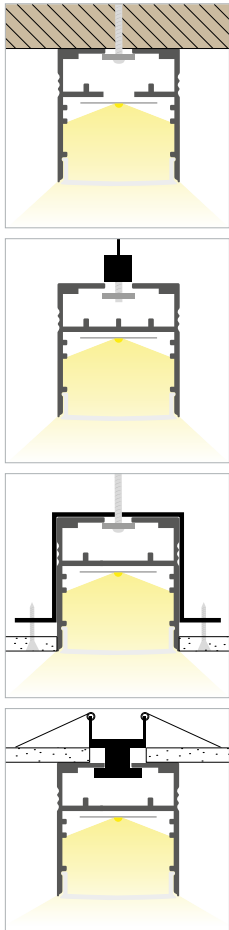

PRF012

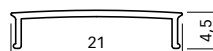

PX01/02/03

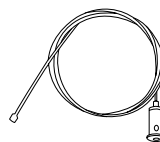

SSP002

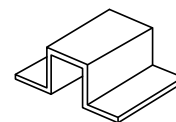

ST03

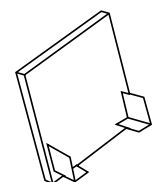

TP01

CODE	DESCRIPTION
PRF012/200	Profilo in alluminio a U per sospensione, barra 2m/Aluminum profile, bar lenght 2m
PRF012PX01	Diffusore in PMMA opale, barra 2m/Opal PMMA diffuser, bar lenght 2m
PRF012PX02	Diffusore in PMMA trasparente, barra 2m/Clear PMMA diffuser, bar lenght 2m
PRF012PX03	Diffusore in PMMA satinato, barra 2m/Frosted PMMA diffuser, bar lenght 2m
PRF020ST01	Staffa per profilo ad incasso/Spring bracket for recessed profile
PRF012TP01	Tappo per profilo serie 012/Cap for profile series 012
PRF012ST03	Staffa per incasso filo cartongesso/Clip for recessed installation in drywalls
SSP002	Kit sospensione con terminali lunghezza 1,5m/Suspension kit lenght 1,5m



PRF012

PRF032

Profilo in alluminio estruso anodizzato da esterno. Con le staffe come accessorio è possibile fissare a cartongesso il prodotto. Il profilo può alloggiare fino a 4 strip LED. Il prodotto si presta per essere personalizzato, dal colore del profilo alla lunghezza, potendo scegliere il tipo di illuminazione che desideriamo. Disponibile anche in barre da 3m, oltre al colore bianco.

Outdoor anodized extruded aluminum profile. Due to the brackets it is possible installation in drywall. Profile allow housing for up to 4 LED strips. Product is suitable to be customized, from its color to its length, making it possible to choose the type of illumination you need. Also available in 3m bars and painted in white.

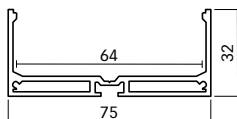

PRF032

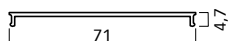

PX05/ PX35

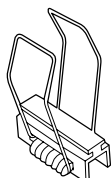

ST01

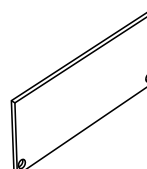

TP01/02

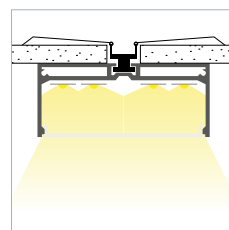
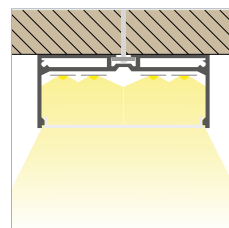

CODE	DESCRIPTION
PRF032/200G	Profilo anodizzato a U, barra da 2m/Aluminum U profile, bar lenght 2m
PRF032/300G	Profilo anodizzato a U, barra da 3m/Aluminum U profile, bar lenght 3m
PRF032/200W	Profilo bianco a U, barra 2m/White Aluminum U profile, bar lenght 2m
PRF032/300W	Profilo bianco a U, barra 3m/White Aluminum U profile, bar lenght 3m
PRF032PX05	Diffusore in PMMA bianco, barra 2m/White PMMA diffuser, bar lenght 2m
PRF032PX35	Diffusore in PMMA bianco, barra 3m/White PMMA diffuser, bar lenght 3m
PRF020ST01	Staffa per profilo ad incasso/Spring bracket for recessed profile
PRF032TP01	Tappo grigio per profilo serie 032/Grey cap for profile series 032
PRF032TP02	Tappo bianco per profilo serie 032/White cap for profile series 032





PRF032

PRF005

Profilo in alluminio estruso anodizzato ad incasso, ideale per l'installazione e raffreddamento delle strip a LED. Dedicato per essere incassato nei sottopensili oppure sotto le mensole. Il prodotto si presta per essere personalizzato, dal colore del profilo alla lunghezza, potendo scegliere il tipo di illuminazione che desideriamo.

Anodized extruded aluminum recessed profile. Suitable for installation and cooling of LED strips. Designed to be recessed in cabinets or shelves. Product is suitable for customization, from its color to its length, making it possible to choose the type of illumination you need.

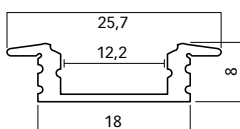
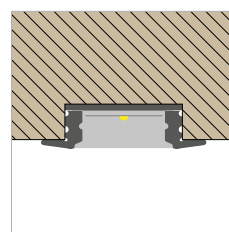
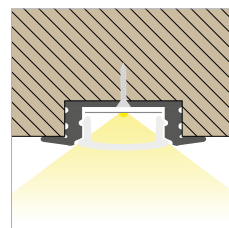

PRF005

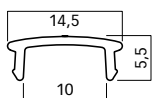

PX01/02

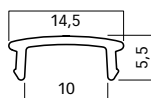

PX31/32



TP01

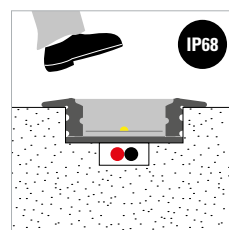

CODE	DESCRIPTION
PRF005/200	Profilo in alluminio con flangia, barra 2m/Aluminum U profile, bar lenght 2m
PRF005/300	Profilo in alluminio con flangia, barra 3m/Aluminum U profile, bar lenght 3m
PRF003PX01	Diffusore in PMMA opale, barra 2m/Opal PMMA diffuser, bar lenght 2m
PRF003PX31	Diffusore in PMMA opale, barra 3m/Opal PMMA diffuser, bar lenght 3m
PRF003PX02	Diffusore in PMMA trasparente, barra 2m/Clear PMMA diffuser, bar lenght 2m
PRF003PX32	Diffusore in PMMA trasparente, barra 3m/Clear PMMA diffuser, bar lenght 3m
PRF005TP01	Tappo per profilo serie 005/Cap for profile series 005





PRF005

PRF020

Profili in alluminio estruso anodizzato da incasso. Con le molle date come accessorio è possibile installare il prodotto nel cartongesso. La profondità del profilo permette l'uniformità della luce (senza vedere i punti LED). Il prodotto si presta per essere personalizzato, dal colore del profilo alla lunghezza, potendo scegliere il tipo di illuminazione che desideriamo.

Recessed anodized extruded aluminum profile. With its specific springs it can be installed in drywall. Profile's depth allow a uniform beam of light (without seeing LEDs points). Product is suitable for customization, from its color to its length, making it possible to choose the type of illumination you need.

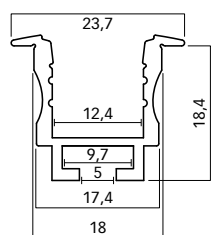
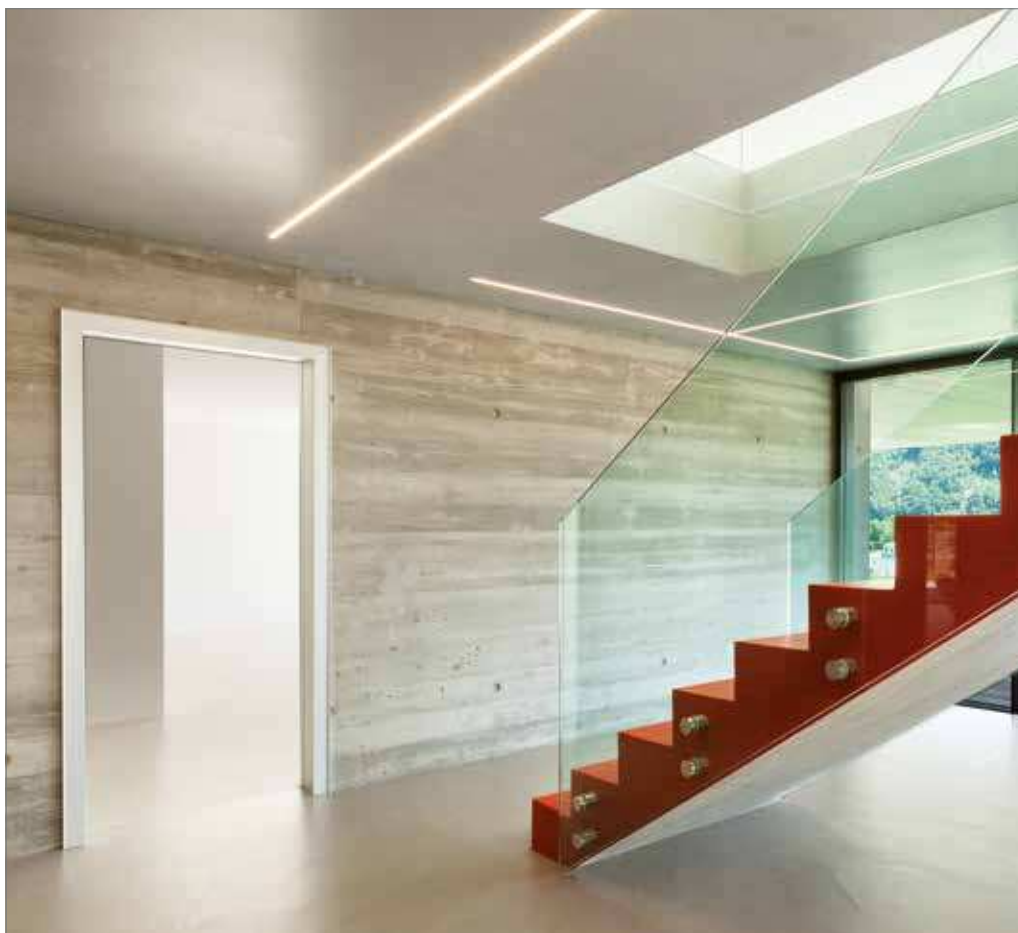
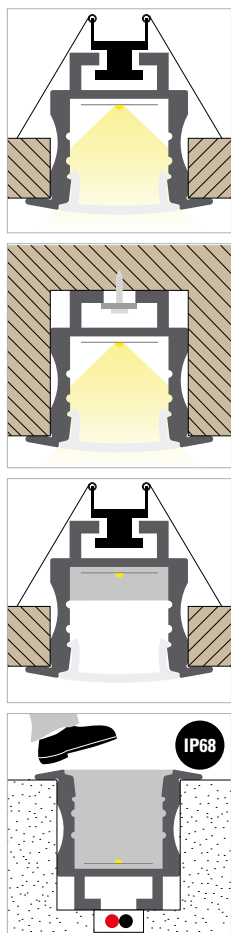

PRF020

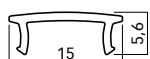

PX01/31

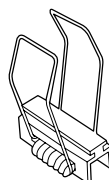

ST01

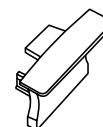

TP01/02

CODE	DESCRIPTION
PRF020/200G	Profilo in alluminio anodizzato ad incasso, barra 2m/Aluminum U profile, bar length 2m
PRF020/300G	Profilo in alluminio anodizzato ad incasso, barra 3m/Aluminum U profile, bar length 3m
PRF020/200W	Profilo bianco in alluminio ad incasso, barra 2m/White Aluminum U profile, bar length 2m
PRF020/300W	Profilo bianco in alluminio ad incasso, barra 3m/White Aluminum U profile, bar length 3m
PRF020PX01	Diffusore in PMMA opale, barra 2m/Opal PMMA diffuser, bar length 2m
PRF020PX31	Diffusore in PMMA opale, barra 3m/Opal PMMA diffuser, bar length 3m
PRF020ST01	Staffa per profilo ad incasso/Spring bracket for recessed profile
PRF020TP01	Tappo grigio per profilo serie 020/Gray cap for profile series 020
PRF020TP02	Tappo bianco per profilo serie 020/White cap for profile series 020

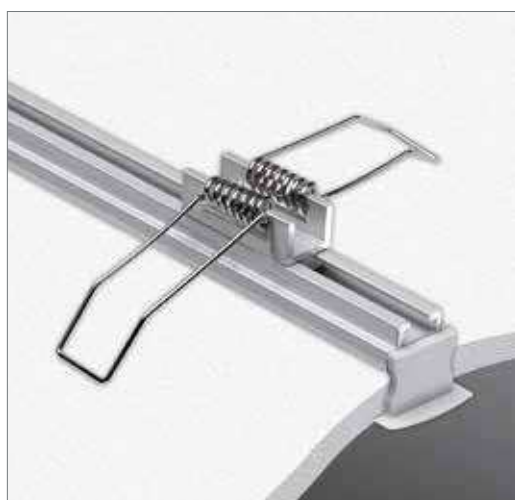

PRF020

PRF013

Profilo in alluminio estruso anodizzato da incasso. Con le molle date come accessorio è possibile installare il prodotto nel cartongesso. Adatto anche per strip LED IP67/68. Il prodotto si presta per essere personalizzato, dal colore del profilo alla lunghezza, potendo scegliere il tipo di illuminazione che desideriamo.

Recessed anodized extruded aluminum profile. Due to the springs given as accessory is also possible to install the profiles in the drywall. Suitable also for IP67/IP68 LED strips. Product is suitable for customization, from its color to its length, making it possible to choose the type of illumination you need.

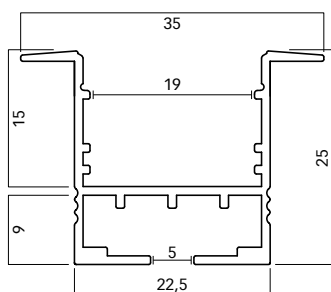
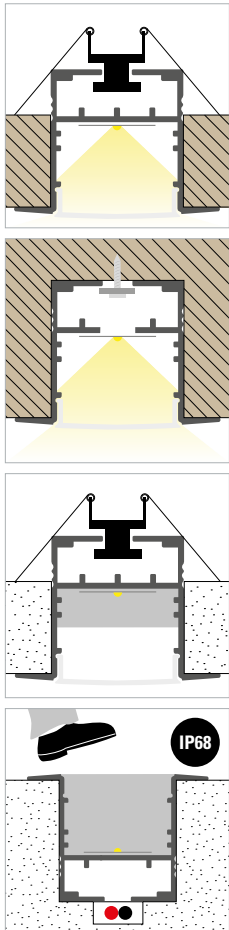

PRF013

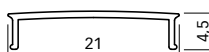

PX01/02



ST01

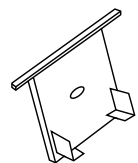

TP01

CODE	DESCRIPTION
PRF013/200	Profilo in alluminio a U con flange per sospensione, barra 2m/Aluminum build-in profile, bar length 2m
PRF012PX01	Diffusore in PMMA opale, barra 2m/Opal PMMA diffuser, bar length 2m
PRF012PX02	Diffusore in PMMA trasparente, barra 2m /Clear PMMA diffuser, bar length 2m
PRF020ST01	Staffa per profilo ad incasso/Spring bracket for recessed profile
PRF013TP01	Tappo per profilo serie 013/Cap for profile series 013

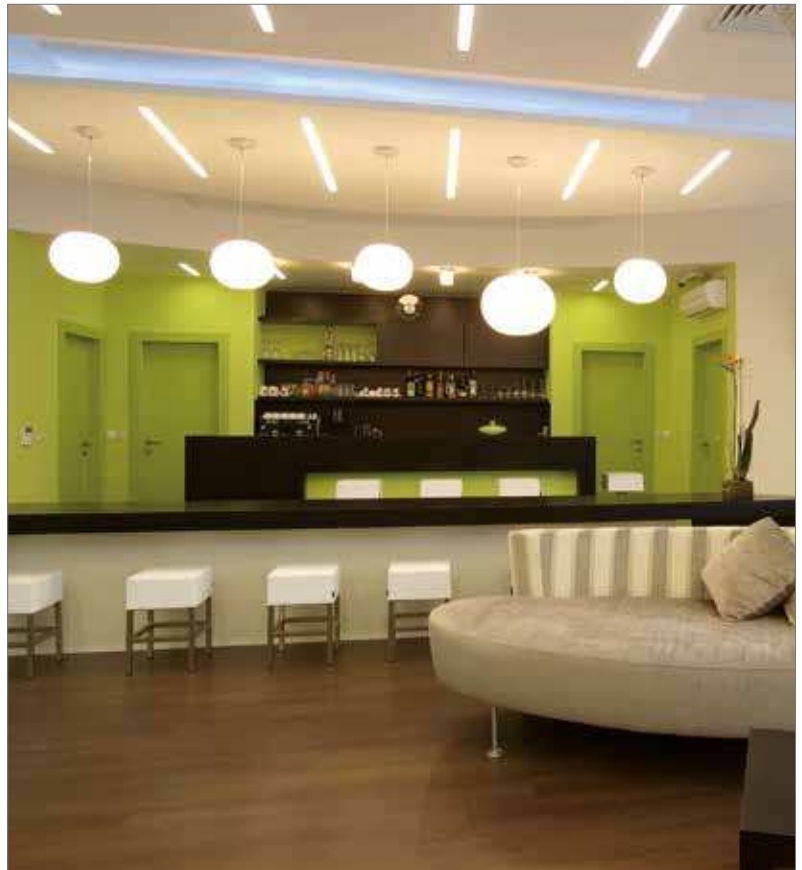

PRF013

PRF009

Profilo in alluminio estruso anodizzato da incasso. Con le staffe date come accessorio è possibile installare il prodotto nel cartongesso. Il prodotto si presta per essere personalizzato, dal colore del profilo alla lunghezza, potendo scegliere il tipo di illuminazione che desideriamo. Il profilo può alloggiare fino a 2 strip LED.

Anodized extruded aluminum profile. Due to the brackets it is possible installation in drywall. Product is suitable to be customized, from its color to its length, making it possible to choose the type of illumination you need. Profile allow housing for up to 2 LED strips.

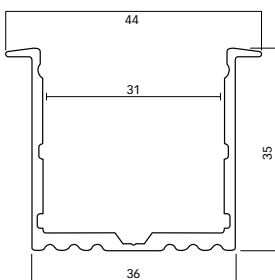

PRF009

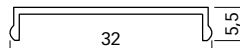

PX01

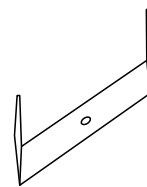

ST01

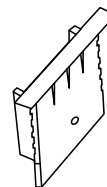

TP01

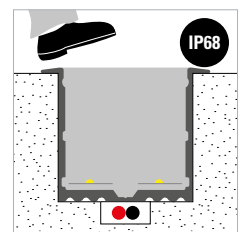
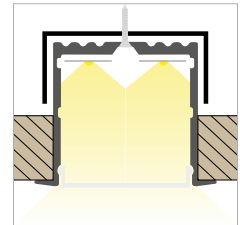

CODE	DESCRIPTION
PRF009/200	Profilo in alluminio a U con flangia, barra 2m/Aluminum build-in profile, bar lenght 2m
PRF009PX01	Diffusore in PMMA opale, barra 2m/Opal PMMA diffuser, bar lenght 2m
PRF009ST01	Staffa per profilo serie 009/Clip for profile series 009
PRF009TP01	Tappo grigio per profilo serie 009/Grey cap for profile series 009





PRF009

PRF035

Profilo in alluminio estruso anodizzato da incasso. Con le staffe date come accessorio è possibile installare il prodotto nel cartongesso. Il prodotto si presta per essere personalizzato, dal colore del profilo alla lunghezza, potendo scegliere il tipo di illuminazione che desideriamo. Il profilo può alloggiare fino a 2 strip LED.

Recessed anodized extruded aluminum profile. Due to the brackets it is possible installation in drywall. Product is suitable to be customized, from its color to its length, making it possible to choose the type of illumination you need. Profile allow housing for up to 2 LED strips.

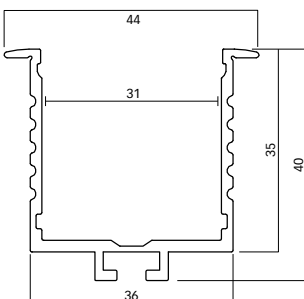
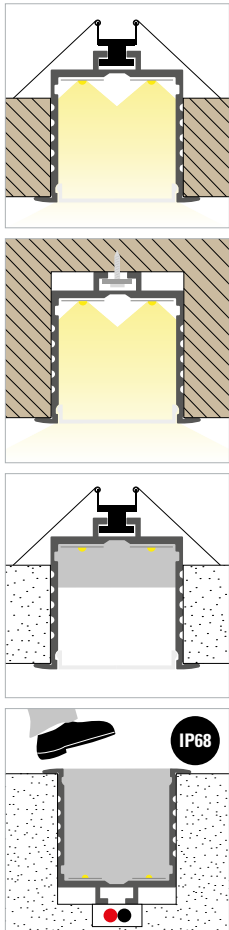

PRF035

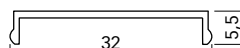

PX01

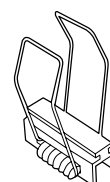

ST01

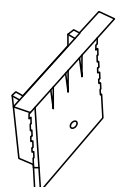

TP01/02

CODE	DESCRIPTION
PRF035/200G	Profilo anodizzato a U con flangia, barra 2m/Recessed white aluminum profile, bar lenght 2m
PRF035/200W	Profilo in alluminio bianco a U con flangia, barra 2m/Recessed anodized aluminum profile, bar lenght 2m
PRF009PX01	Diffusore in PMMA opale, barra 2m/Opal PMMA diffuser, bar lenght 2m
PRF020ST01	Staffa per profilo ad incasso/Spring bracket for recessed profile
PRF035TP01	Tappo grigio per profilo serie 035/Grey cap for profile series 035
PRF035TP02	Tappo bianco per profilo serie 035/White cap for profile series 035

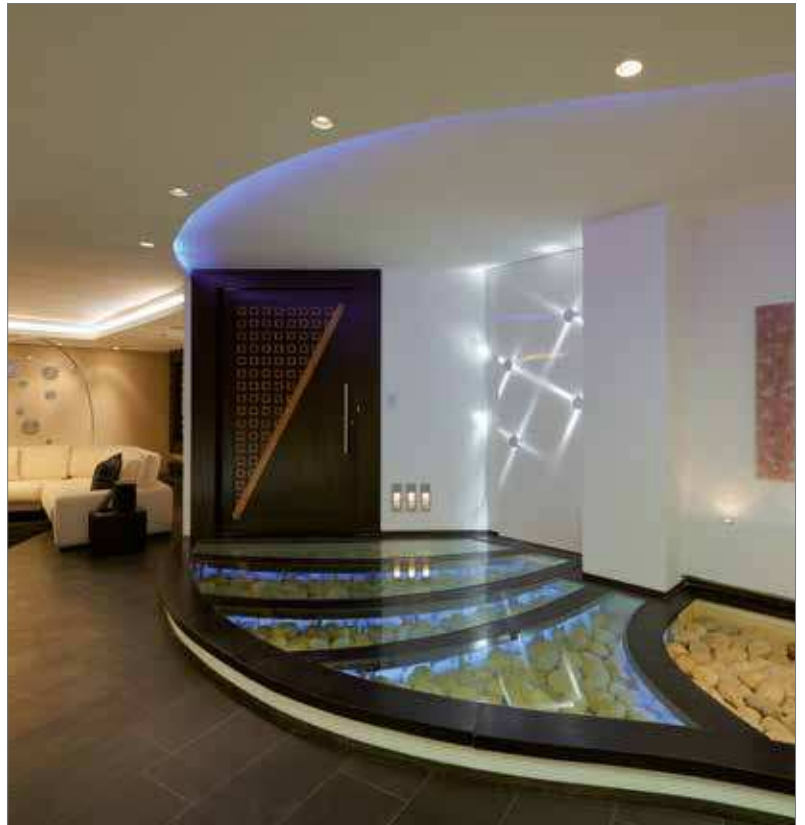

PRF035

PRF036

Profilo in alluminio estruso anodizzato da incasso. Con le staffe date come accessorio è possibile installare il prodotto nel cartongesso. Il profilo può alloggiare fino a 4 strip LED. Il prodotto si presta per essere personalizzato, dal colore del profilo alla lunghezza, potendo scegliere il tipo di illuminazione che desideriamo. Disponibile anche in barre da 3m, oltre al colore bianco.

Recessed anodized extruded aluminum profile. Due to the brackets it is possible installation in drywall. Product is suitable to be customized, from its color to its length, making it possible to choose the type of illumination you need. Also available in 3m bars and painted in white.

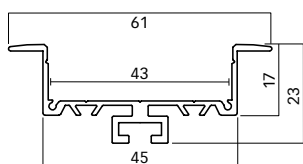

PRF036

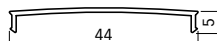

PX01/31

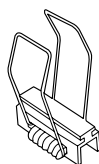

ST01

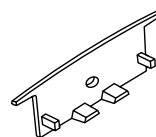

TP01/02

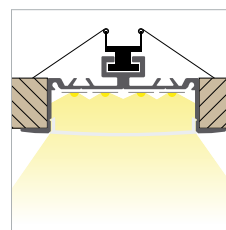

CODE	DESCRIPTION
PRF036/200G	Profilo anodizzato ad incasso, barra da 2m/ <i>Recessed anodized aluminum profile, bar lenght 2m</i>
PRF036/300G	Profilo anodizzato ad incasso, barra da 3m/ <i>Recessed anodized aluminum profile, bar lenght 3m</i>
PRF036/200W	Profilo in alluminio bianco ad incasso, barra 2m/ <i>Recessed white aluminum profile, bar lenght 2m</i>
PRF036/300W	Profilo in alluminio bianco ad incasso, barra 3m/ <i>Recessed white aluminum profile, bar lenght 3m</i>
PRF036PX01	Diffusore in PMMA opale, barra 2m/ <i>Opal PMMA diffuser, bar lenght 2m</i>
PRF036PX31	Diffusore in PMMA opale, barra 3m/ <i>Opal PMMA diffuser, bar lenght 3m</i>
PRF020ST01	Staffa per profilo ad incasso/ <i>Spring bracket for recessed profile</i>
PRF036TP01	Tappo grigio per profilo serie 036/ <i>Grey cap for profile series 036</i>
PRF036TP02	Tappo bianco per profilo serie 036/ <i>White cap for profile series 036</i>

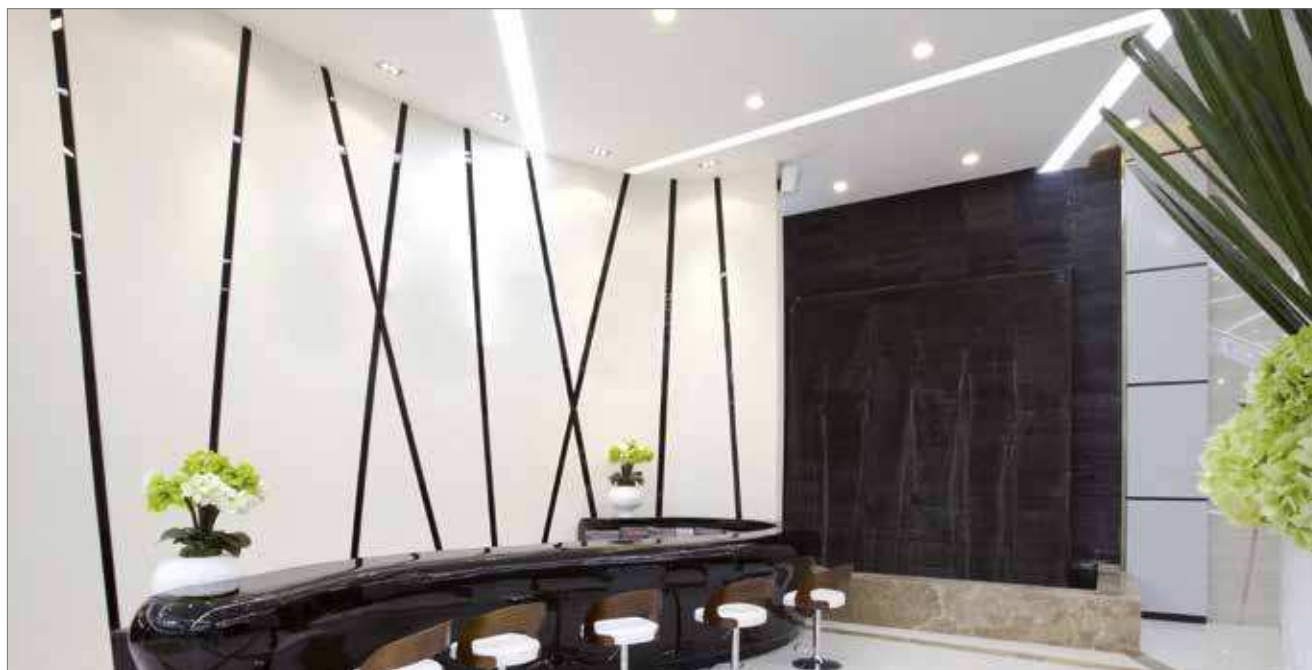



PRF036

PRF033

Profilo in alluminio estruso anodizzato da incasso. Con le staffe date come accessorio è possibile installare il prodotto nel cartongesso. Il profilo può alloggiare fino a 4 strip LED. Il prodotto si presta per essere personalizzato, dal colore del profilo alla lunghezza, potendo scegliere il tipo di illuminazione che desideriamo. Disponibile anche in barre da 3m, oltre al colore bianco.

Recessed anodized extruded aluminum profile. Due to the brackets it is possible installation in drywall. Profile allow housing for up to 4 LED strips. Product is suitable to be customized, from its color to its length, making it possible to choose the type of illumination you need. Also available in 3m bars and painted in white.

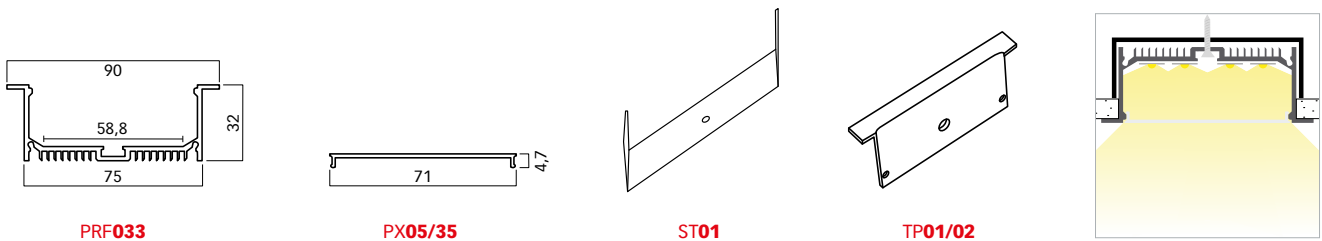

PRF033

PX05/35

ST01

TP01/02

CODE	DESCRIPTION
PRF033/200G	Profilo anodizzato ad incasso a U con flange, barra da 2m/ <i>Recessed aluminum U profile, bar lenght 2m</i>
PRF033/300G	Profilo anodizzato ad incasso a U con flange, barra da 3m/ <i>Recessed aluminum U profile, bar lenght 3m</i>
PRF033/200W	Profilo bianco ad incasso a U con flange, barra 2m/ <i>Recessed white Aluminum U profile, bar lenght 2m</i>
PRF033/300W	Profilo bianco ad incasso a U con flange, barra 3m/ <i>Recessed white Aluminum U profile, bar lenght 3m</i>
PRF032PX05	Diffusore in PMMA bianco, barra 2m/ <i>White PMMA diffuser, bar lenght 2m</i>
PRF032PX35	Diffusore in PMMA bianco, barra 3m/ <i>White PMMA diffuser, bar lenght 3m</i>
PRF033ST01	Staffa per profilo ad incasso/ <i>Spring bracket for recessed profile</i>
PRF033TP01	Tappo grigio per profilo serie 033/ <i>Grey cap for profile series 033</i>
PRF033TP02	Tappo bianco per profilo serie 033/ <i>White cap for profile series 033</i>



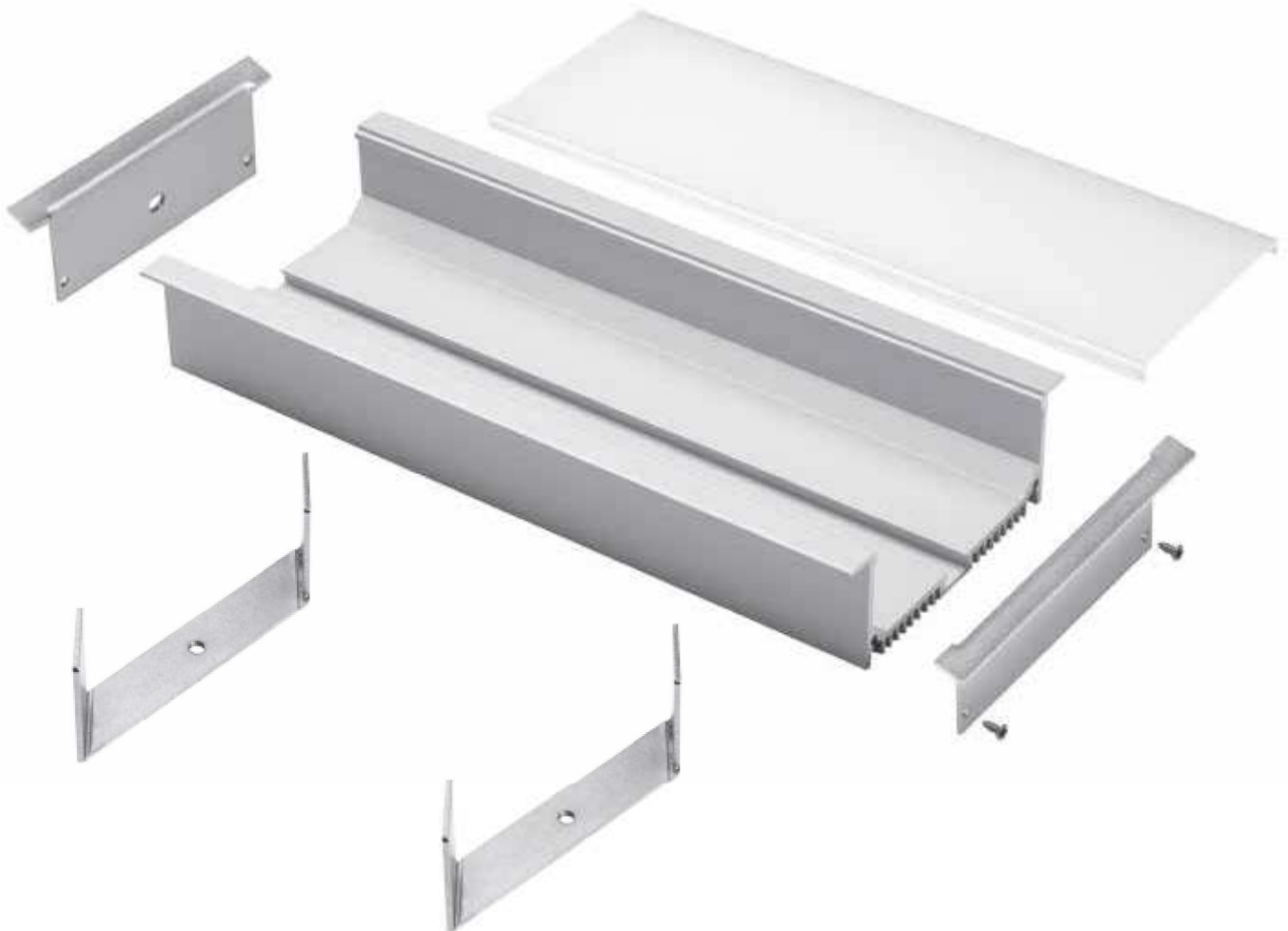

PRF033

PRF007

Profilo in alluminio estruso anodizzato angolare, ideale per l'installazione e raffreddamento delle strip a LED. Dedicato per essere installato nei sottopensili, il diffusore a tutto schermo rende invisibile la struttura. Il prodotto si presta per essere personalizzato, dal colore del profilo alla lunghezza, potendo scegliere il tipo di illuminazione che desideriamo.

Anodized extruded aluminum angular profile. Suitable for installation and cooling of LED strips. Designed to be installed under cabinet. Round diffuser allow the profile to be invisible once installed. Product is suitable for customization, from its color to its length, making it possible to choose the type of illumination you need.

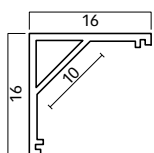
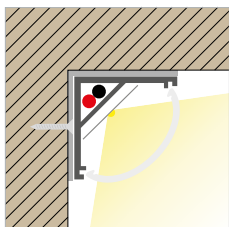

PRF007

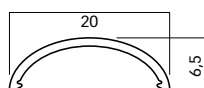

PX03/33

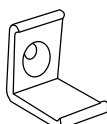

ST01

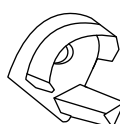

TP01/02

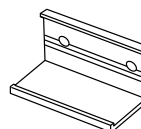

CL01/02

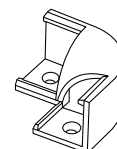

CN01/02

CODE	DESCRIPTION
PRF007/200	Profilo in alluminio ad angolo, barra 2m/Aluminum V profile, bar length 2m
PRF007/300	Profilo in alluminio ad angolo, barra 3m/Aluminum V profile, bar length 3m
PRF007PX03	Diffusore in PMMA satinato, barra 2m/Frosted PMMA diffuser, bar length 2m
PRF007PX33	Diffusore in PMMA satinato, barra 3m/Frosted PMMA diffuser, bar length 3m
PRF007ST01	Staffa per profilo serie 007/Clip for profile series 007
PRF007TP01	Tappo grigio per profilo serie 007/Gray cap for profile series 007
PRF007TP02	Tappo bianco per profilo serie 007/White cap for profile series 007
PRF007CL01	Connettore lineare grigio/Linear connector gray
PRF007CL02	Connettore lineare bianco/Linear connector white
PRF007CN01	Connettore angolare grigio/Corner connector gray
PRF007CN02	Connettore angolare bianco/Corner connector white

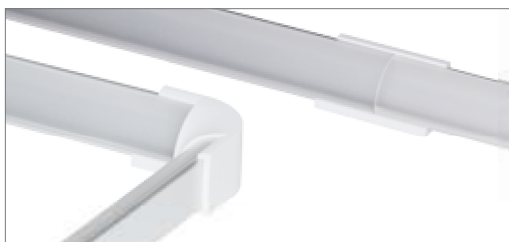

PRF007

PRF027

Profilo in alluminio estruso anodizzato angolare, ideale per l'installazione e raffreddamento delle strip a LED. Dedicato per essere installato nei sottopensili, il diffusore a tutto schermo rende invisibile la struttura. Il prodotto si presta per essere personalizzato, dal colore del profilo alla lunghezza, potendo scegliere il tipo di illuminazione che desideriamo.

Anodized extruded aluminum angular profile. Suitable for installation and cooling of LED strips. Designed to be installed under cabinet. Round diffuser allow the profile to be invisible once installed. Product is suitable for customization, from its color to its length, making it possible to choose the type of illumination you need.

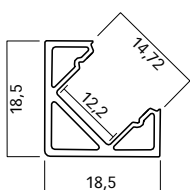
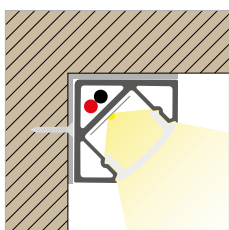

PRF027

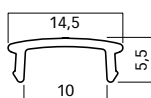

PX01/02

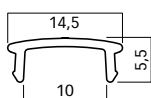

PX31/32

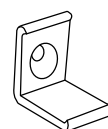

ST01

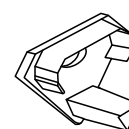

TP01

CODE	DESCRIPTION
PRF027/200	Profilo anodizzato ad angolo, barra 2m/Corner aluminum profile, bar length 2m
PRF003PX01	Diffusore in PMMA opale, barra 2m/Opal PMMA diffuser, bar length 2m
PRF003PX31	Diffusore in PMMA opale, barra 3m/Opal PMMA diffuser, bar length 3m
PRF003PX02	Diffusore in PMMA trasparente, barra 2m/Clear PMMA diffuser, bar length 2m
PRF003PX32	Diffusore in PMMA trasparente, barra 3m/Clear PMMA diffuser, bar length 3m
PRF027ST01	Staffa per profilo serie 027/Clip for profile series 027
PRF027TP01	Tappo grigio per profilo serie 027/Cap for profile series 027



PRF027

PRF028

Profilo in alluminio estruso anodizzato angolare grande, ideale per l'installazione e raffreddamento delle strip a LED. Dedicato per essere installato nei sottopensili, il diffusore a tutto schermo rende invisibile la struttura. Il prodotto si presta per essere personalizzato, dal colore del profilo alla lunghezza, potendo scegliere il tipo di illuminazione che desideriamo. Il profilo può alloggiare fino a 2 strip LED.

Anodized extruded aluminum big angular profile. Suitable for installation and cooling of LED strips. Designed to be installed under cabinet. Round diffuser allow the profile to be invisible once installed. Product is suitable for customization, from its color to its length, making it possible to choose the type of illumination you need. Profile allow housing for up to 2 LED strip.

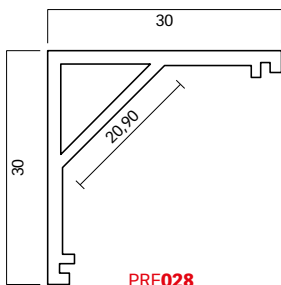

PRF028

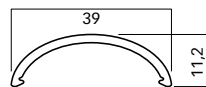

PX03/33

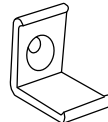

ST01

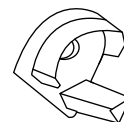

TP01/02

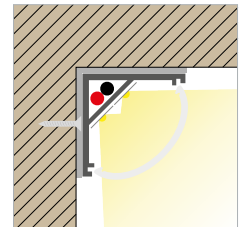

CODE	DESCRIPTION
PRF028/200	Profilo anodizzato ad angolo, barra 2m/Corner aluminum profile, bar lenght 2m
PRF028PX03	Diffusore in PMMA satinato, barra 2m/Frosted PMMA diffuser, bar lenght 2m
PRF028PX33	Diffusore in PMMA satinato, barra 3m/Frosted PMMA diffuser, bar lenght 3m
PRF028ST01	Staffa per profilo serie 028/Cap for profile series 028
PRF028TP01	Tappo grigio per profilo serie 028/Clip for profile series 028
PRF028TP02	Tappo bianco per profilo serie 028/Clip for profile series 028



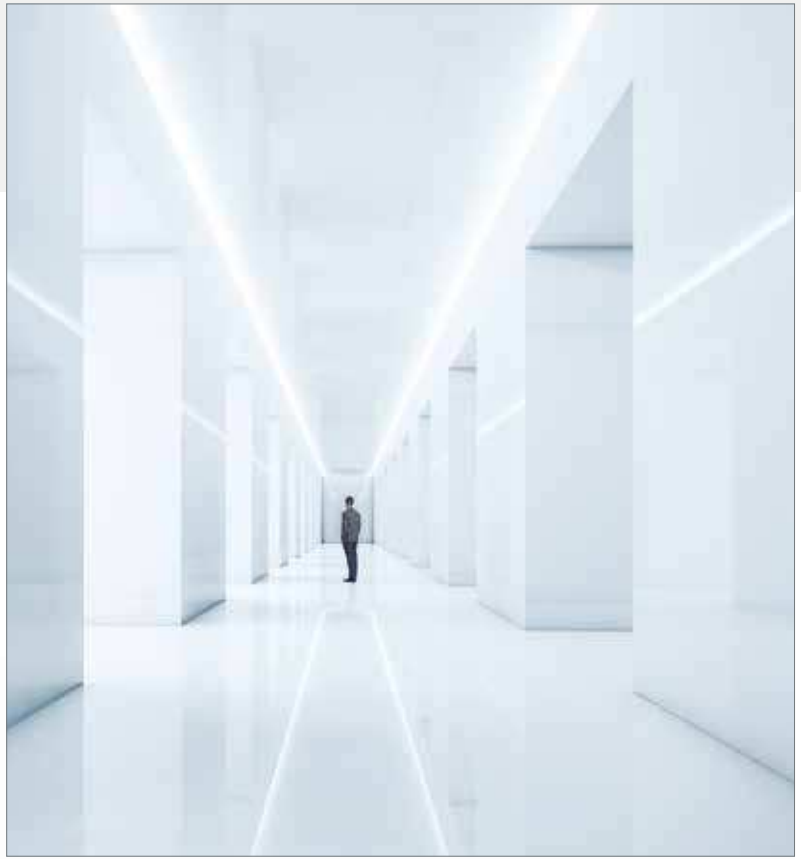

PRF028

PRF014

Profilo in alluminio estruso, mono emissione di luce. Dedicato per essere installato a parete, rende il fascio di luce un elemento decorativo dell'ambiente. Il prodotto si presta per essere personalizzato, dal colore del profilo alla lunghezza, potendo scegliere il tipo di illuminazione che desideriamo. Disponibile anche in barre da 3m, oltre al colore bianco.

Extruded aluminum profile, single light emission. Designed for wall installation, it makes the bundle of light a decorative element for the environment. Product is suitable to be customized, from its color to its length, making it possible to choose the type of illumination you need. Also available in 3m bars and painted in white.

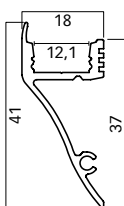
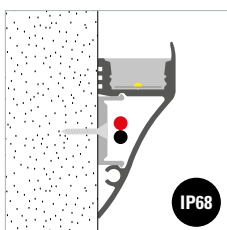
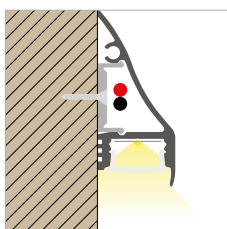
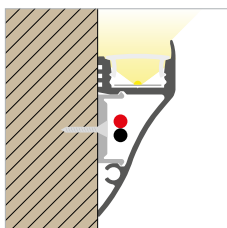

PRF014

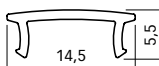

PX01/02

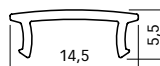

PX31/32

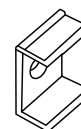

ST01



TP01/02

CODE	DESCRIPTION
PRF014/200G	Profilo da parete in alluminio anodizzato, barra 2m/Anodized aluminum profile wall, bar lenght 2m
PRF014/300G	Profilo da parete in alluminio anodizzato, barra 3m/Anodized aluminum profile wall, bar lenght 3m
PRF014/200W	Profilo decorativo a parete bianco, barra 2m/White aluminum profile wall, bar lenght 2m
PRF014/300W	Profilo decorativo a parete bianco, barra 3m/White aluminum profile wall, bar lenght 3m
PRF014PX01	Diffusore in PMMA opale, barra 2m/Opal PMMA diffuser, bar lenght 2m
PRF014PX31	Diffusore in PMMA opale, barra 3m/Opal PMMA diffuser, bar lenght 3m
PRF014PX02	Diffusore in PMMA trasparente, barra 2m/Clear PMMA diffuser, bar lenght 2m
PRF014PX32	Diffusore in PMMA trasparente, barra 3m/Clear PMMA diffuser, bar lenght 3m
PRF014ST01	Staffa per profilo serie 014/Clip for profile series 014
PRF014TP01	Tappo grigio per profilo serie 014/Grey cap for profile series 014
PRF014TP02	Tappo bianco per profilo serie 014/White cap for profile series 014

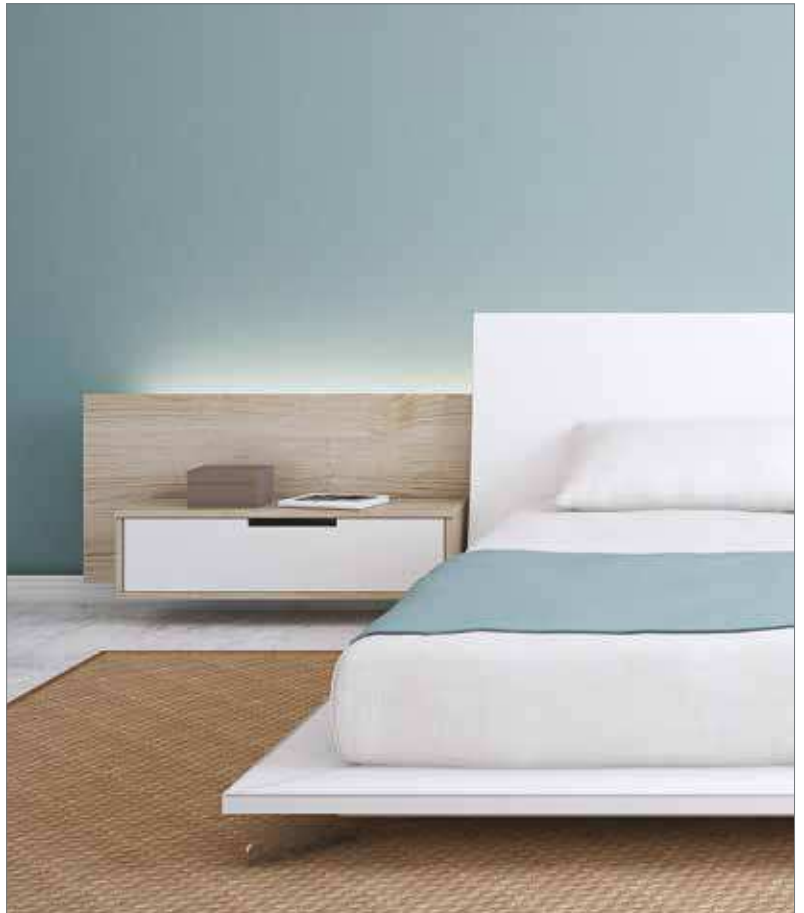

PRF014

PRF034

Profilo in alluminio estruso, doppia emissione di luce. Dedicato per essere installato a parete, rende il fascio di luce un elemento decorativo dell'ambiente. Il prodotto si presta per essere personalizzato, dal colore del profilo alla lunghezza, potendo scegliere il tipo di illuminazione che desideriamo. Disponibile anche in barre da 3m, oltre al colore bianco.

Extruded aluminum profile, double light emission. Designed for wall installation, it makes the bundle of light a decorative element for the environment. Product is suitable to be customized, from its color to its length, making it possible to choose the type of illumination you need. Also available in 3m bars and painted in white.

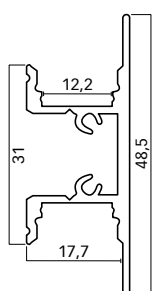

PRF034

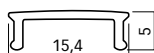

PX01/02

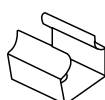

ST01

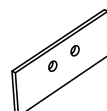

TP01/02

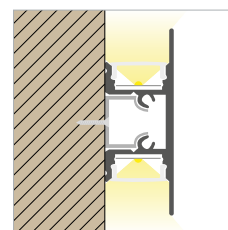

CODE	DESCRIPTION
PRF034/200G	Profilo anodizzato da parete bi-emissione, barra da 2m/Double wall light aluminum profile, bar lenght 2m
PRF034/300G	Profilo anodizzato da parete bi-emissione, barra da 3m/Double wall light aluminum profile, bar lenght 3m
PRF034/200W	Profilo bianco da parete bi-emissione, barra 2m/White double wall light aluminum profile, bar lenght 2m
PRF034/300W	Profilo bianco da parete bi-emissione, barra 3m/White double wall light aluminum profile, bar lenght 3m
PRF034PX01	Diffusore in PMMA opale, barra 2m/Opal PMMA diffuser, bar lenght 2m
PRF034PX02	Diffusore in PMMA trasparente, barra 2m/Clear PMMA diffuser, bar lenght 2m
PRF034ST01	Staffa per profilo serie 034/Clip for profile series 034
PRF034TP01	Tappo grigio per profilo serie 034/Grey cap for profile series 034
PRF034TP02	Tappo bianco per profilo serie 034/White cap for profile series 034



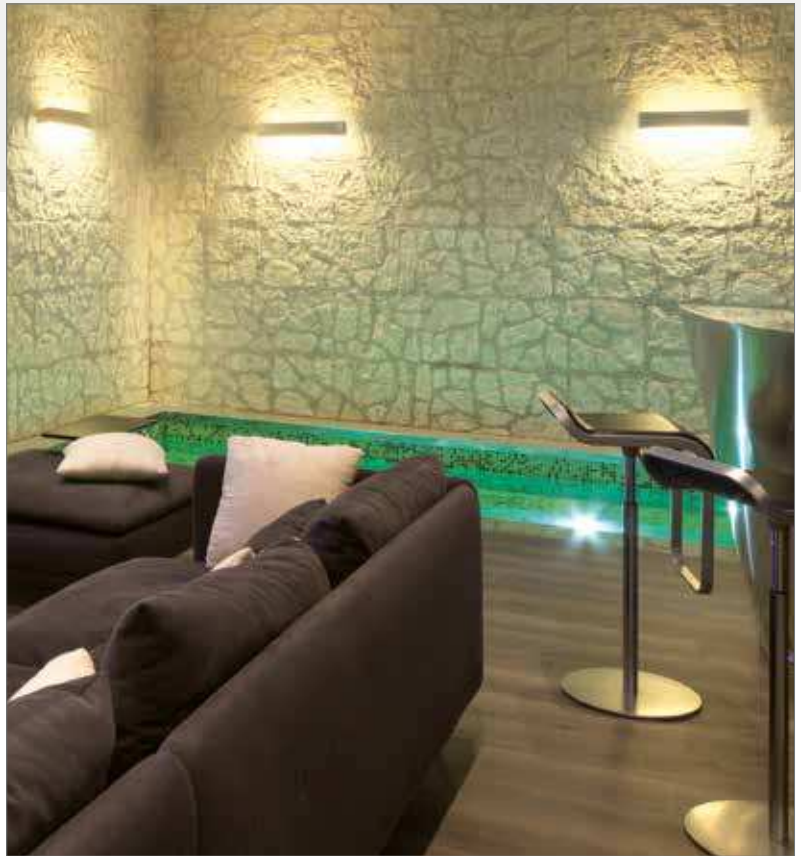
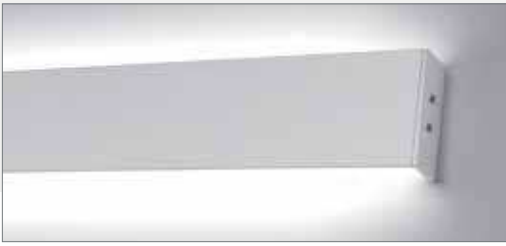

PRF034

PRF016

Profilo in alluminio estruso anodizzato da parete. Le due emissioni di luce (superiore ed inferiore) permettono di differenziare anche il colore della stessa. All'interno del prodotto è possibile installare l'alimentatore. Il prodotto si presta per essere personalizzato, dal colore del profilo alla lunghezza, potendo scegliere il tipo di illuminazione che desideriamo. Disponibile anche in barre da 3m, oltre al colore bianco.

Wall extruded aluminum profile. Both light emissions (upper and lower) also allow to change light color between the bundles of light. Inside the product is also possible to install the power supply. Product is suitable to be customized, from its color to its length, making it possible to choose the type of illumination you need. Also available in 3m bars and painted in white.

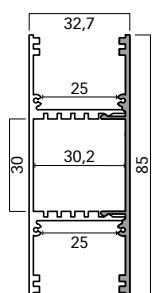

PRF016

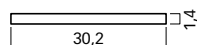

PX01/02

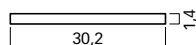

PX31/32

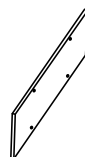

TP01

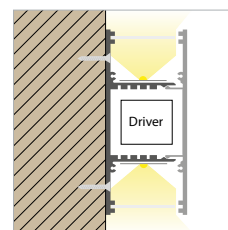

CODE	DESCRIPTION
PRF016/200G	Profilo da parete in alluminio a doppio fascio di luce, barra 2m/Anodized aluminum profile wall, bar lenght 2m
PRF016/300G	Profilo da parete in alluminio a doppio fascio di luce, barra 3m/Anodized aluminum profile wall, bar lenght 3m
PRF016/200W	Profilo da parete bianco a doppio fascio di luce, barra 2m/White aluminum profile wall, bar lenght 2m
PRF016/300W	Profilo da parete bianco a doppio fascio di luce, barra 3m/White aluminum profile wall, bar lenght 3m
PRF016PX01	Diffusore in PMMA opale, barra 2m/Opal PMMA diffuser, bar lenght 2m
PRF016PX31	Diffusore in PMMA opale, barra 3m/Opal PMMA diffuser, bar lenght 3m
PRF016PX02	Diffusore in PMMA trasparente, barra 2m/Clear PMMA diffuser, bar lenght 2m
PRF016PX32	Diffusore in PMMA trasparente, barra 3m/Clear PMMA diffuser, bar lenght 3m
PRF016TP01	Tappo per profilo serie 016/Cap for profile series 016

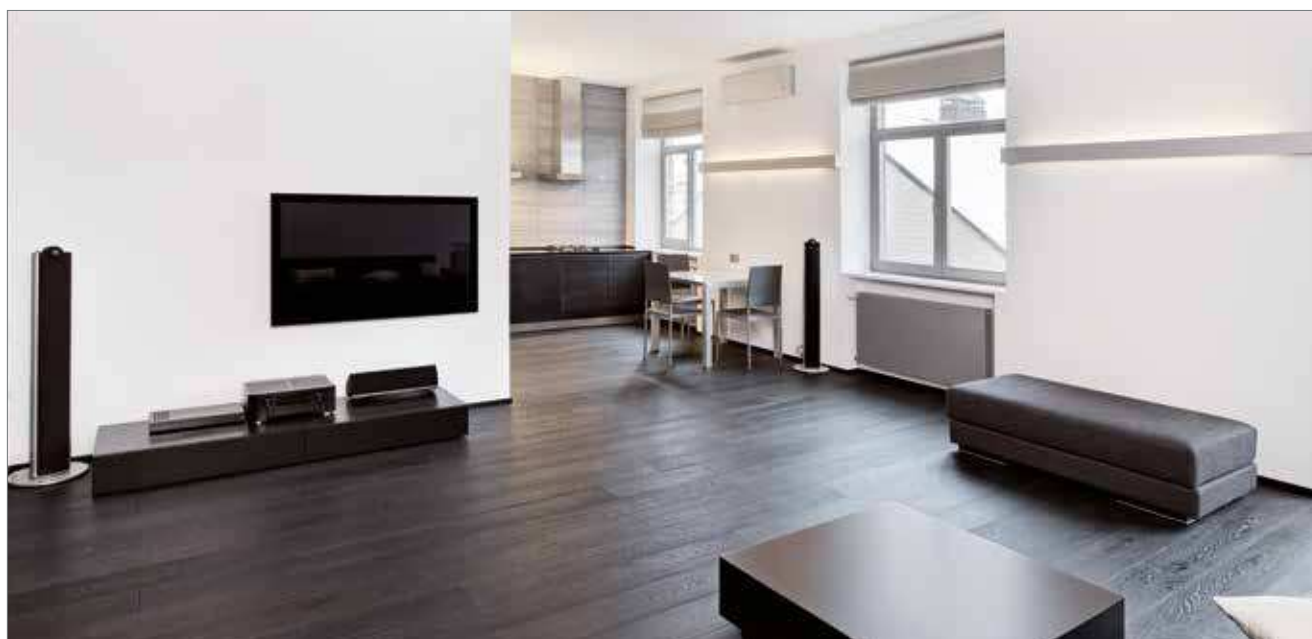

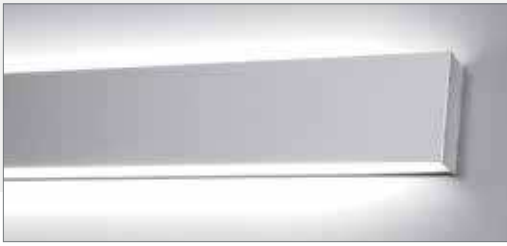

PRF016

PRF006

Profilo in alluminio estruso anodizzato rotondo. Le staffe rendono il prodotto basculante permettendo di indirizzare il fascio di luce. Il kit a sospensione permette di sospendere la sorgente luminosa e fare un gioco di luci. Il prodotto si presta per essere personalizzato, dal colore del profilo alla lunghezza, potendo scegliere il tipo di illuminazione che desideriamo.

Extruded anodized aluminum round profile. The profile can be installed with mounting brackets making it adjustable or it can be suspended with a suspensios kit. This solution is recommended to make game of lights. Product is suitable for customization, from its color to its lenght, making it possible to choose the type of illumination you need.

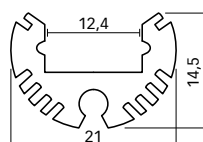
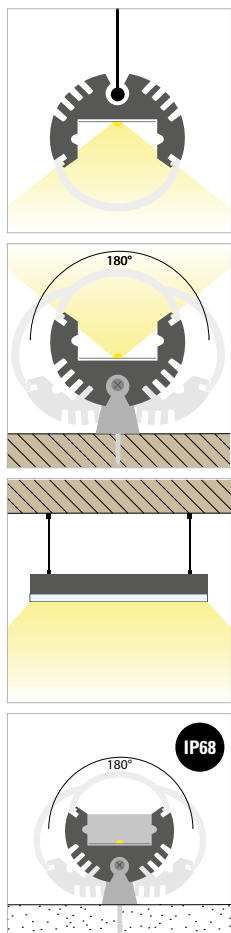

PRF006

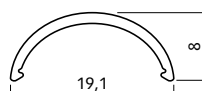

PX03

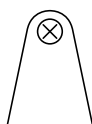

ST01



ST02

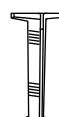

ST03

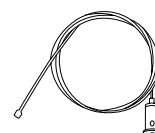

SSP001



TP01

CODE	DESCRIPTION
PRF006/200	Profilo in alluminio tondo, barra 2m/Aluminum U profile, bar lenght 2m
PRF006PX03	Diffusore in PMMA satinato, barra 2m/Frosted PMMA diffuser, bar lenght 2m
PRF006ST01	Staffa per profilo serie 006/Clip for profile series 006
PRF006ST02	Staffa per profilo serie 006/Clip for profile series 006
PRF006ST03	Staffa per profilo serie 006/Clip for profile series 006
PRF006TP01	Tappo per profilo serie 006/Cap for profile series 006
SSP001	Kit sospensione con terminali lunghezza 1,5m/Suspension kit lenght 1,5m



PRF006

PRF010

Profilo in alluminio estruso anodizzato. Prodotto a sospensione ideale per illuminare uffici. Disponibile in due lunghezze 120cm e 150cm. All'interno del prodotto è possibile installare l'alimentatore. Il prodotto si presta per essere personalizzato, dal colore del profilo alla lunghezza, potendo scegliere il tipo di illuminazione che desideriamo.

Anodized extruded aluminum profile. Suspension profile ideal for office illumination. Available in two lengths: 120cm and 150cm. It is possible to lodge the power supply inside the profile. Product is suitable for customization, from its color to its length, making it possible to choose the type of illumination you need.

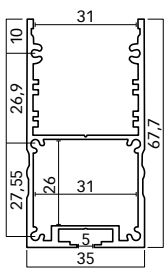

PRF010

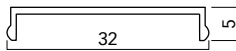

PX11/21

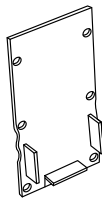

TP01/02

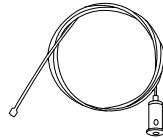

SSP002

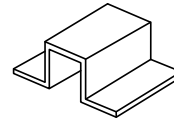

ST03

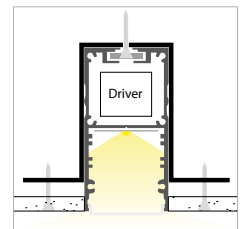
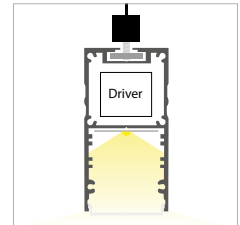

CODE	DESCRIPTION
PRF010/120	Profilo in alluminio a sospensione, barra 120cm/Aluminum suspension profile, bar length 120cm
PRF010/150	Profilo in alluminio a sospensione, barra 150cm/Aluminum suspension profile, bar length 150cm
PRF010/200	Profilo in alluminio a sospensione, barra 200cm/Aluminum suspension profile, bar length 200cm
PRF010PX01	Diffusore in PMMA opale, barra 200cm/Opal PMMA diffuser, bar length 200cm
PRF010PX11	Diffusore in PMMA opale, barra 120cm/Opal PMMA diffuser, bar length 120cm
PRF010PX21	Diffusore in PMMA opale, barra 150cm/Opal PMMA diffuser, bar length 150cm
PRF010TP01	Tappo grigio per profilo serie 010/Gray cap for profile series 010
PRF010TP02	Tappo bianco per profilo serie 010/White cap for profile series 010
PRF010ST03	Staffa per incasso filo cartongesso/Clip for recessed installation in drywalls
SSP002	Kit sospensione con terminali lunghezza 1,5m/Suspension kit length 1,5m





PRF010

PRF022

Profilo in alluminio estruso anodizzato piatto. Prodotto a sospensione ideale per illuminare uffici. All'interno del prodotto è possibile installare fino a 6 barre LED. Il prodotto si presta per essere personalizzato, dal colore del profilo alla lunghezza, potendo scegliere il tipo di illuminazione che desideriamo.

Anodized extruded aluminum flat profile. Suspension item ideal for office lighting. Inside the product is possible to install up to 6 LED bars. Product is suitable for customization, from its color to its length, making it possible to choose the type of illumination you need.

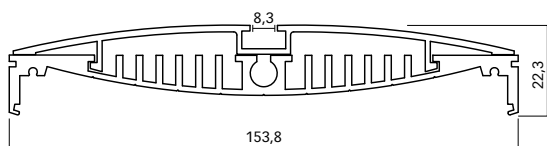

PRF022

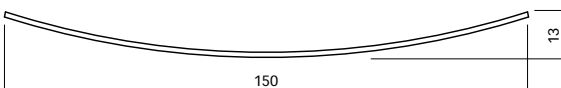

PX01

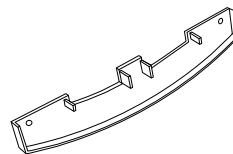

TPP01

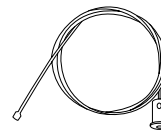

SSP003

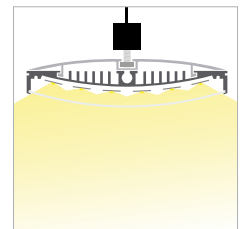
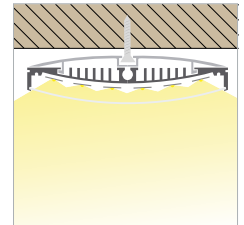

CODE	DESCRIPTION
PRF022/200	Profilo a sospensione per alte potenze, barra 2m/Aluminum profile flat, bar length 2m
PRF022PX01	Diffusore in PMMA opale, barra 2m/Opal PMMA diffuser, bar length 2m
PRF022TP01	Tappo per profilo serie 022 completo di viti/Cap for profile series 022
SSP003	Kit sospensione con terminali lunghezza 1,5m/Suspension kit length 1,5m





PRF022

PRF015

Profilo in alluminio estruso anodizzato ad incasso, ideale per l'installazione e raffreddamento delle strip a LED. Dedicato per essere incassato nelle strutture in cartongesso. Ideale per l'illuminazione notturna negli alberghi. Il prodotto si presta per essere personalizzato, dal colore del profilo alla lunghezza, potendo scegliere il tipo di illuminazione che desideriamo.

Anodized extruded aluminum profile. Suitable for installation and cooling of LED strips. Designed to be recessed in drywalls. Ideal for hotel's night illumination. Product is suitable for customization, from its color to its length, making it possible to choose the type of illumination you need.

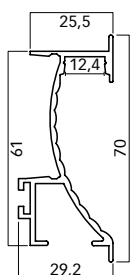

PRF015

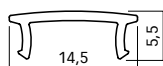

PX01/02

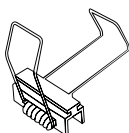

ST01

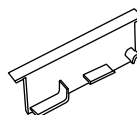

TP01

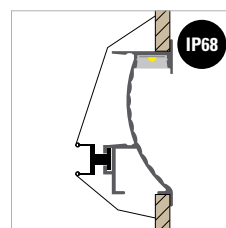
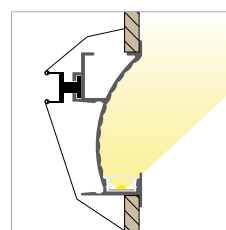
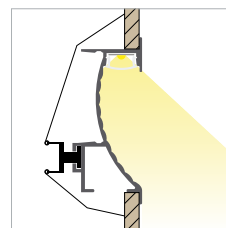

CODE	DESCRIPTION
PRF015/200	Profilo in alluminio a parete, barra 2m/Aluminum build-in profile, bar length 2m
PRF014PX01	Diffusore in PMMA opale, barra 2m/Opal PMMA diffuser, bar length 2m
PRF014PX02	Diffusore in PMMA trasparente, barra 2m/Clear PMMA diffuser, bar length 2m
PRF015ST01	Staffa per profilo serie 015/Clip for profile series 015
PRF015TP01	Tappo per profilo serie 015/Cap for profile series 015



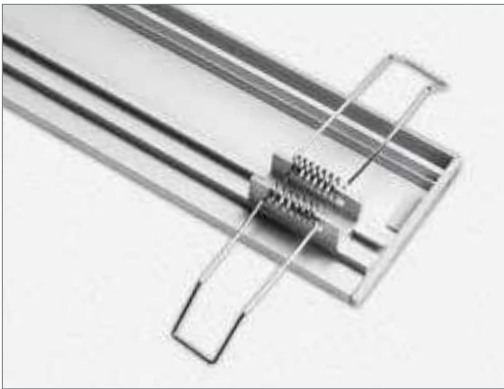

PRF015

PRF018/019

Profilo in alluminio estruso anodizzato. Studiato per illuminare le mensole in vetro. Tre soluzioni differenti per avere un buon effetto decorativo. Il prodotto si presta per essere personalizzato, dal colore del profilo alla lunghezza, potendo scegliere il tipo di illuminazione che desideriamo.

Anodized extruded aluminum profile. Designed to illuminate glass shelves. Three different solutions to have a good decorative effect. Product is suitable for customization, from its color to its length, making it possible to choose the type of illumination you need.

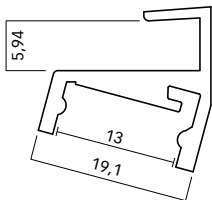

PRF018

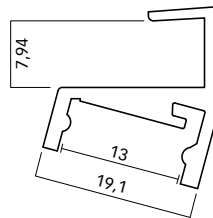

PRF019

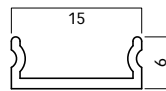

PX01/03

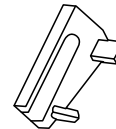

TP01



CODE	DESCRIPTION
PRF018/200	Profilo in alluminio per mensole in cristallo da 6 mm, barra 2m/Aluminum profile, bar lenght 2m
PRF019/200	Profilo in alluminio per mensole in cristallo da 8 mm, barra 2m/Aluminum profile, bar lenght 2m
PRF019PX01	Diffusore in PMMA opale, barra 2m/Opal PMMA diffuser, bar lenght 2m
PRF019PX03	Diffusore in PMMA satinato, barra 2m/Frosted PMMA diffuser, bar lenght 2m
PRF019TP01	Tappo per profilo serie 018/019/Cap for profile series 018/019



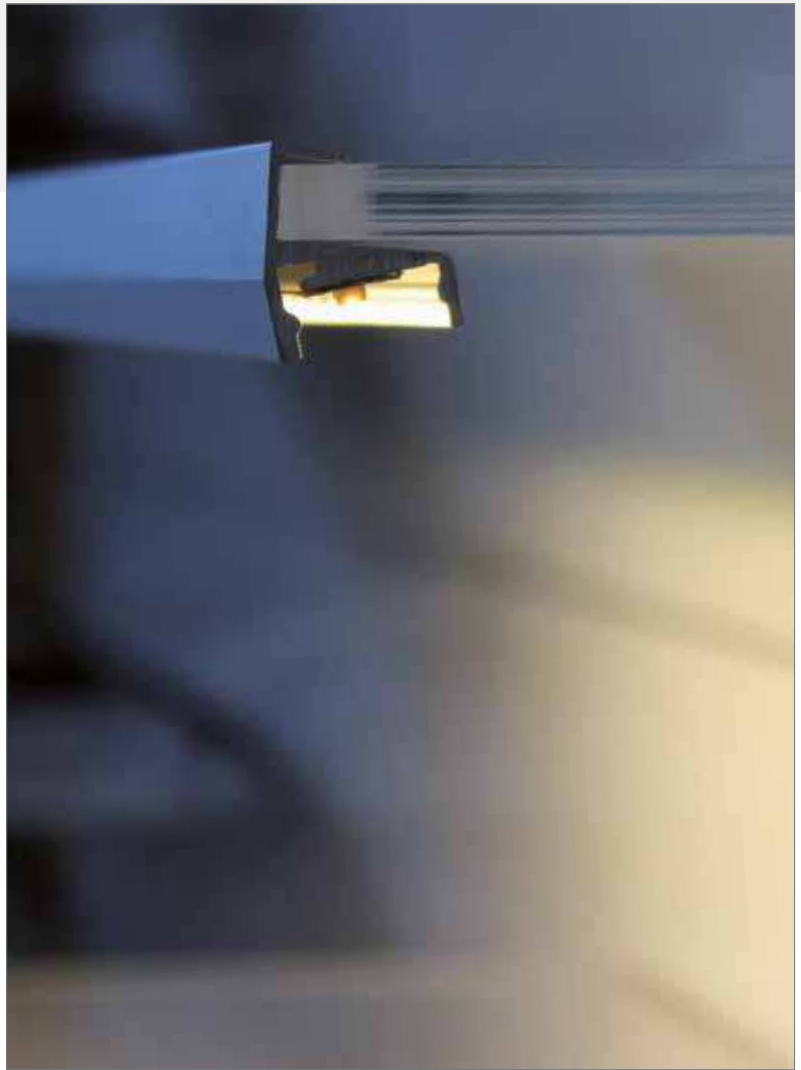

PRF018/019

PRF023

Profilo in alluminio estruso anodizzato. Studiato per illuminare le mensole in vetro. Tre soluzioni differenti per avere un buon effetto decorativo. Il prodotto si presta per essere personalizzato, dal colore del profilo alla lunghezza, potendo scegliere il tipo di illuminazione che desideriamo.

Anodized extruded aluminum profile. Designed to illuminate glass shelves. Three different solutions to have a good decorative effect. Product is suitable for customization, from its color to its length, making it possible to choose the type of illumination you need.

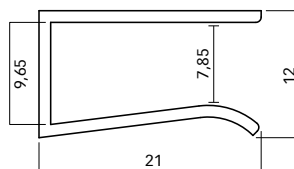

PRF023

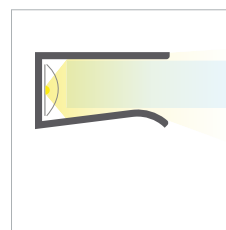

CODE	DESCRIPTION
PRF023/200	Profilo in alluminio per mensole in cristallo da 8 mm, barra 2m/Aluminum profile, bar lenght 2m





PRF023

PRF021

Profilo in alluminio estruso anodizzato. Studiato per essere calpestato ed avere l'illuminazione del gradino senza essere abbagliati. Essendo composto da due elementi, il prodotto è facilmente installabile. Il prodotto si presta per essere personalizzato, dal colore del profilo alla lunghezza, potendo scegliere il tipo di illuminazione che desideriamo.

Anodized extruded aluminum profile. Designed for trampling and for garden lighting with no glare effect. Composed by two elements, the product is easily installable. Product is suitable for customization, from its color to its length, making it possible to choose the type of illumination you need.

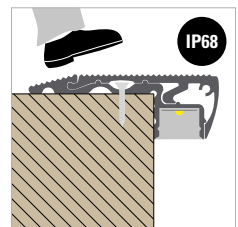
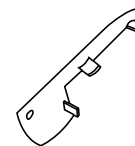
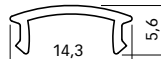
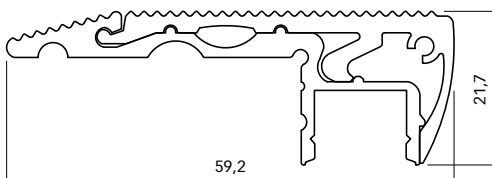
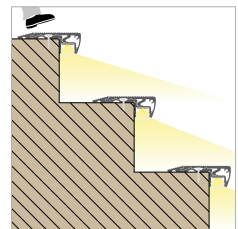
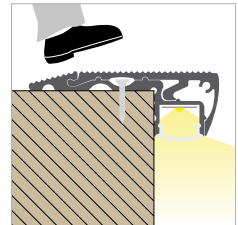

PRF021

PX01

TP01

CODE	DESCRIPTION
PRF021/200	Profilo in alluminio per gradini, barra 2m/Aluminum profile for step, bar length 2m
PRF021PX01	Diffusore in PMMA opale, barra 2m/Opal PMMA diffuser, bar length 2m
PRF021TP01	Tappo per profilo serie 021/Cap for profile series 021

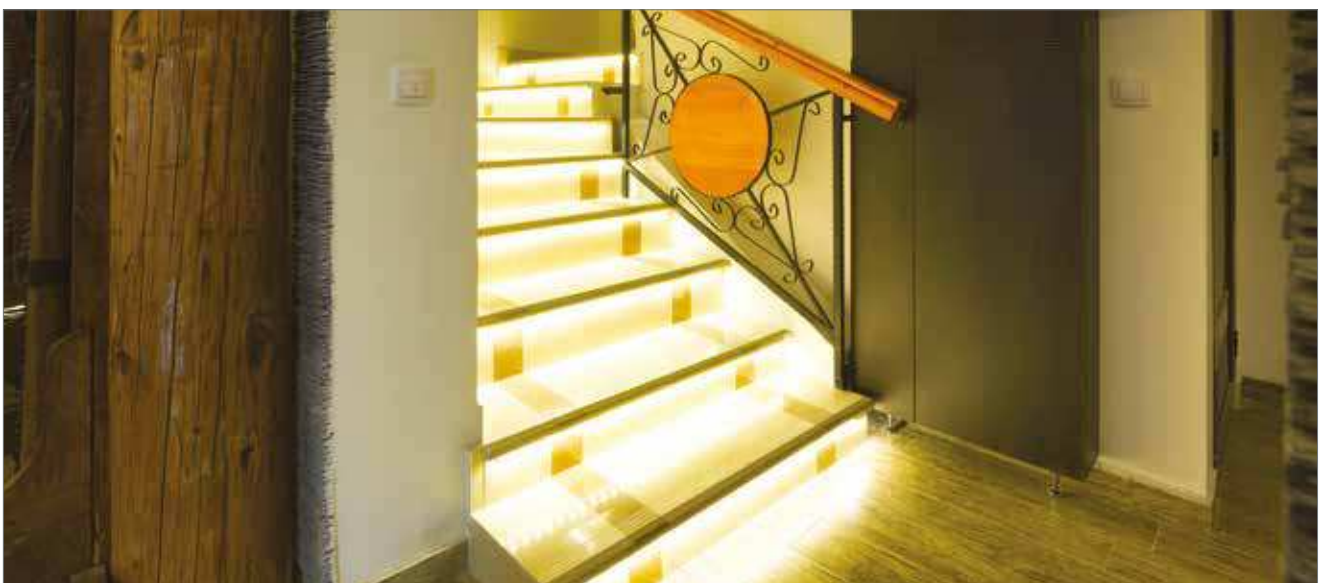



PRF021

PRF038 IP54

Profilo in alluminio estruso anodizzato da interno. Studiato per essere installato a terra, il prodotto è totalmente calpestabile. Cementato nel corpo del pavimento. Il diffusore bianco rende omogenea la propagazione della luce senza vedere il classico puntino LED. Essendo composto da due elementi, il prodotto è facilmente installabile. Si presta per essere personalizzato, dal colore del profilo alla lunghezza, potendo scegliere il tipo di illuminazione che desideriamo.

Indoor anodized extruded aluminum profile. Designed for ground installation, product is completely walkable. Cemented in the floor. White diffuser makes homogeneous light diffusion preventing to see the single LED points. Composed by two elements product is easily installable. Product is suitable to be customized, from its color to its length, making it possible to choose the type of illumination you need.

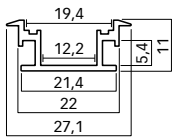

PRF038

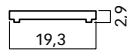

PX05

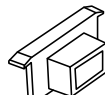

TP01

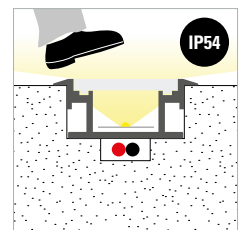

CODE	DESCRIPTION
PRF038/200	Profilo in alluminio calpestabile, barra da 2m/Walkable aluminum profile, bar length 2m
PRF038PX05	Diffusore in policarbonato bianco/White polycarbonate diffuser, bar length 2m
PRF038TP01	Tappo per profilo serie 038/Cap for profile series 038





PRF038

PRF024

Profilo in alluminio estruso anodizzato calpestabile. Il prodotto si presta per essere personalizzato, dal colore del profilo alla lunghezza, potendo scegliere il tipo di illuminazione che desideriamo.

Walkable anodized extruded aluminum profile. Product is suitable for customization, from its color to its length, making it possible to choose the type of illumination you need.

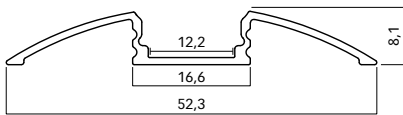

PRF024

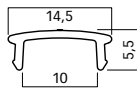

PX01/02

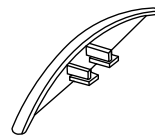

TP01

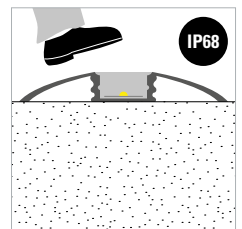
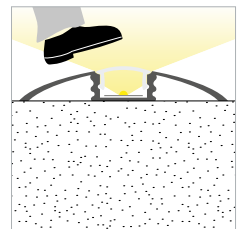
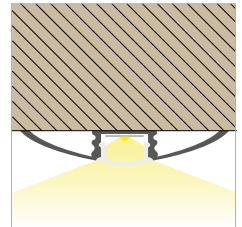

CODE	DESCRIPTION
PRF024/200	Profilo calpestabile in alluminio a U con flange, barra 2m/Aluminum profile, bar length 2m
PRF003PX01	Diffusore in PMMA opale, barra 2m/Opal PMMA diffuser, bar length 2m
PRF003PX02	Diffusore in PMMA trasparente, barra 2m/Clear PMMA diffuser, bar length 2m
PRF024TP01	Tappo per profilo serie 024/Cap for profile series 024





PRF024

PRF025 IP65

Profilo in alluminio anodizzato IP65 ad incasso. Il diffusore e i tappi ermetici rendono il profilo protetto dall'acqua. Consigliato per ambienti esterni e celle frigo.

IP65 recessed anodized aluminum profile. Hermetic diffuser and caps make the profile water-resistant. Suggested for outdoor applications and for cold stores.

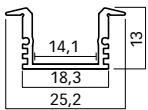

PRF025

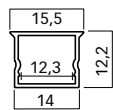

PX05

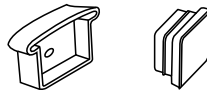

TP02

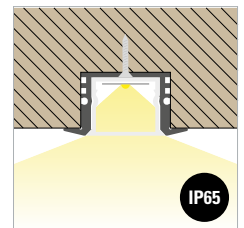

CODE	DESCRIPTION
PRF025/200	Profilo anodizzato ad incasso IP65 con flange, barra 2m/Aluminum profile IP65, bar lenght 2m
PRF026PX05	Diffusore in PMMA bianco con piattina, barra 2m/White PMMA diffuser with aluminum flat, bar lenght 2m
PRF025TP02	Tappo e controtappo bianco per profilo serie 025/White cap for profile series 025

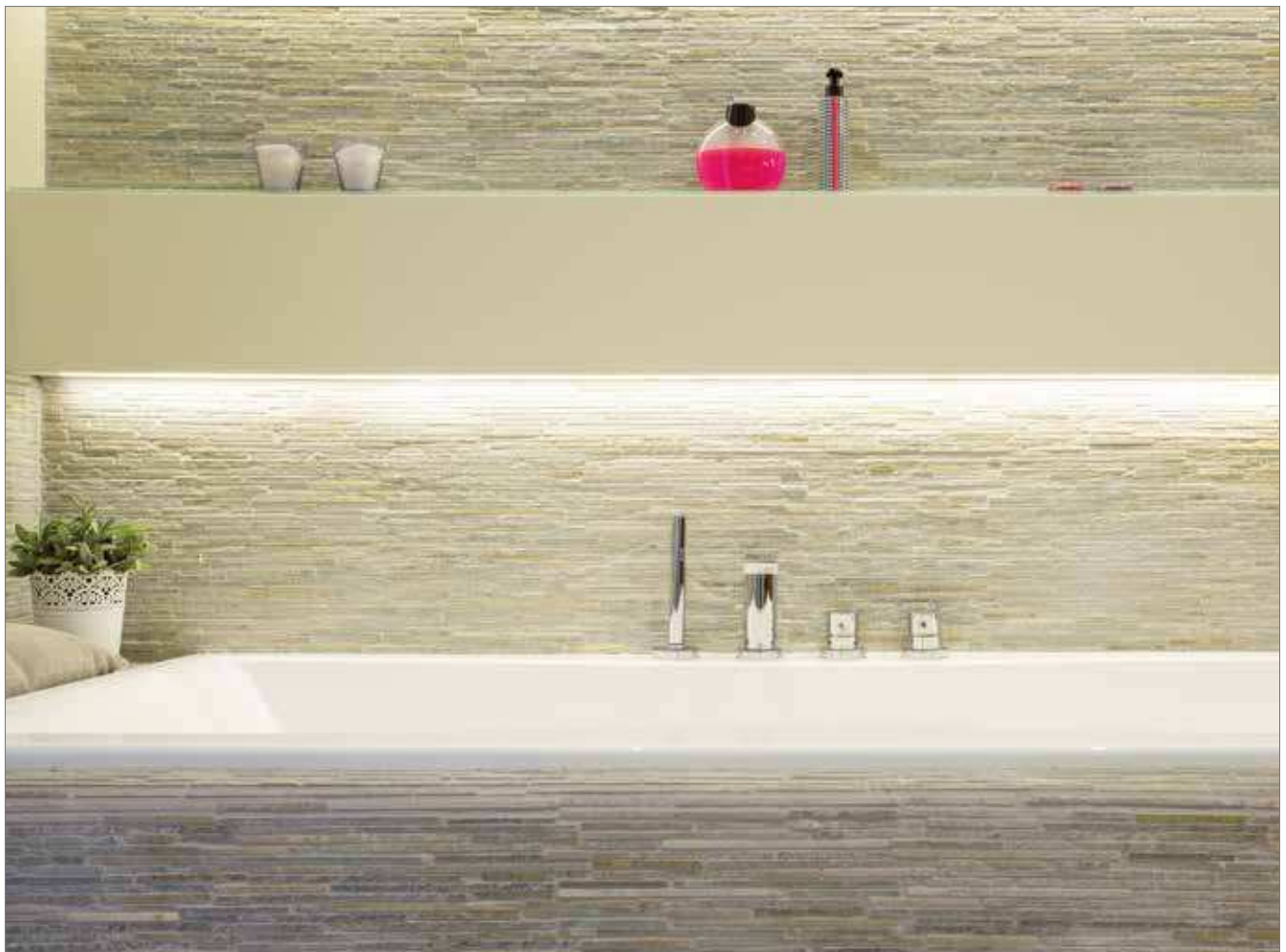



PRF025

PRF026 IP65

Profilo in alluminio anodizzato IP65. Il diffusore e i tappi ermetici rendono il profilo protetto dall'acqua. Consigliato per ambienti esterni e celle frigo.

IP65 recessed anodized aluminum profile. Hermetic diffuser and caps make the profile water-resistant. Suggested for outdoor applications and for cold stores.

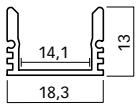

PRF026

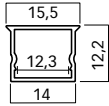

PX05

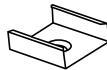

ST01



TP02

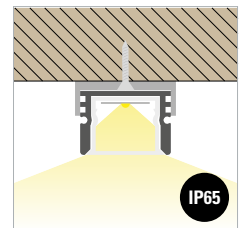

CODE	DESCRIPTION
PRF026/200	Profilo anodizzato a U IP65, barra 2m/ <i>Recessed aluminum profile IP65, bar lenght 2m</i>
PRF026PX05	Diffusore in PMMA bianco con piattina, barra 2m/ <i>White PMMA diffuser with aluminum flat, bar lenght 2m</i>
PRF026ST01	Staffa per profilo serie 026/ <i>Clip for profile series 026</i>
PRF026TP02	Tappo e controtappo bianco per profilo serie 026/ <i>White cap for profile series 026</i>



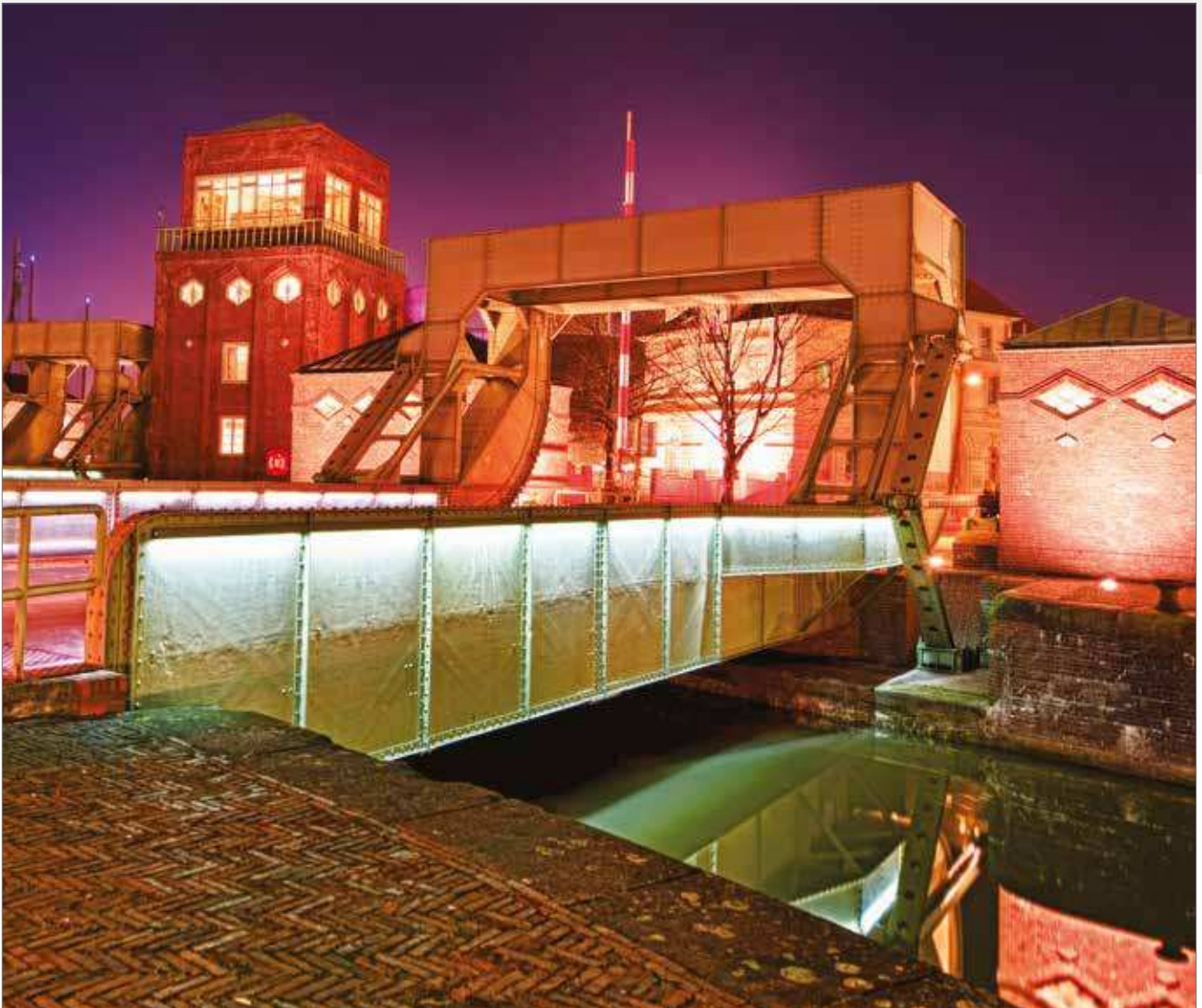

PRF026

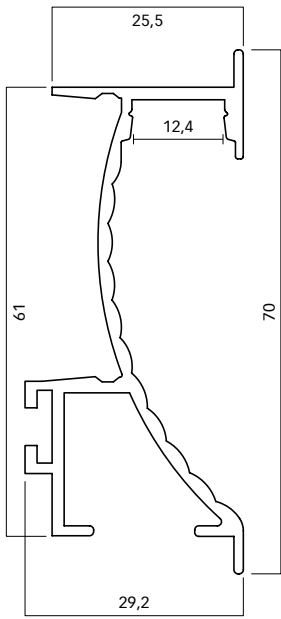

PRF015

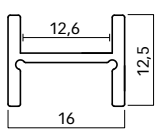

PRF031

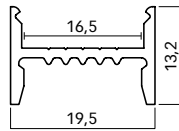

PRF011

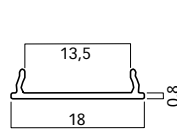

PRF030

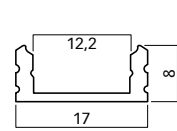

PRF004

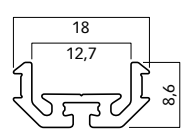

PRF003

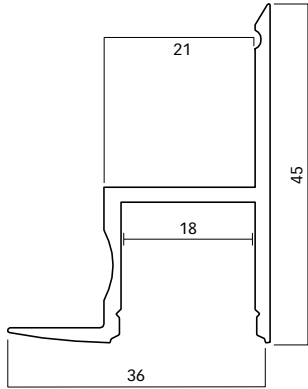

PRF029

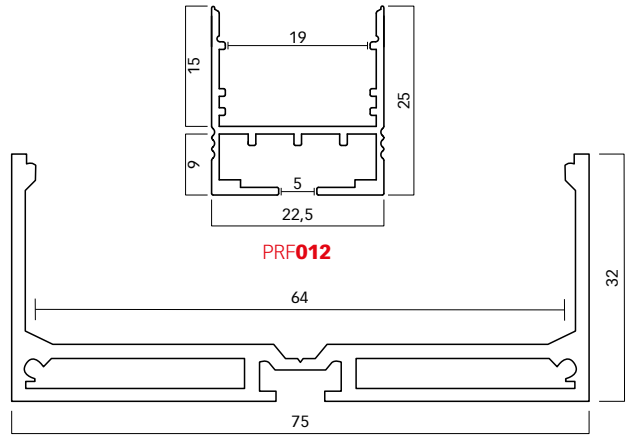

PRF012

PRF032

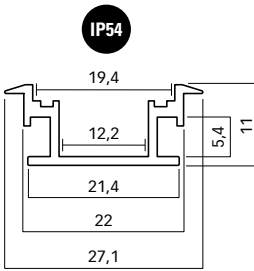

PRF038

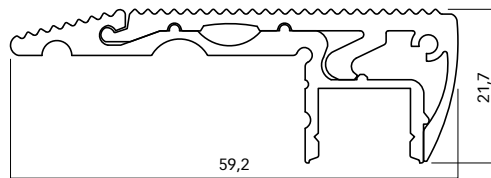

PRF021

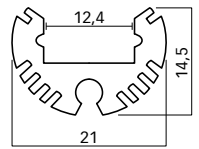

PRF006

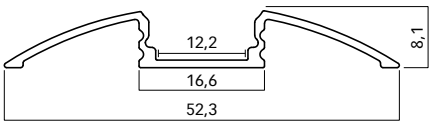

PRF024

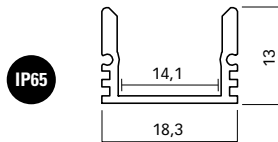

PRF026

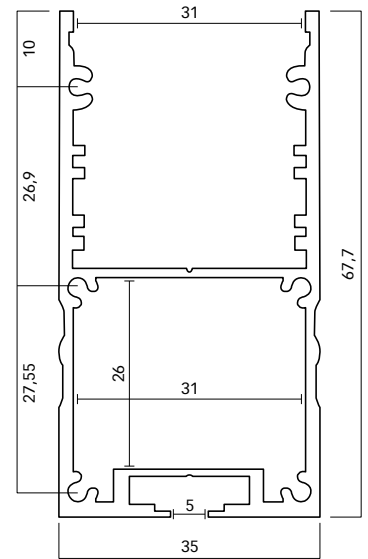

PRF010

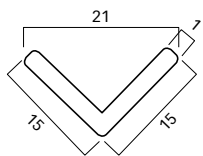

PRF008

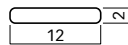

PRF002

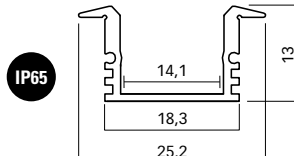

PRF025

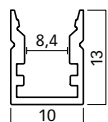

PRF017

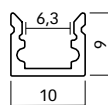

PRF037

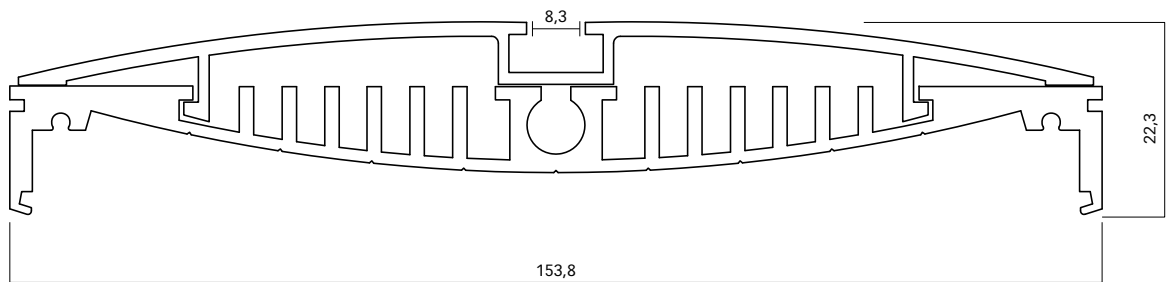

PRF022

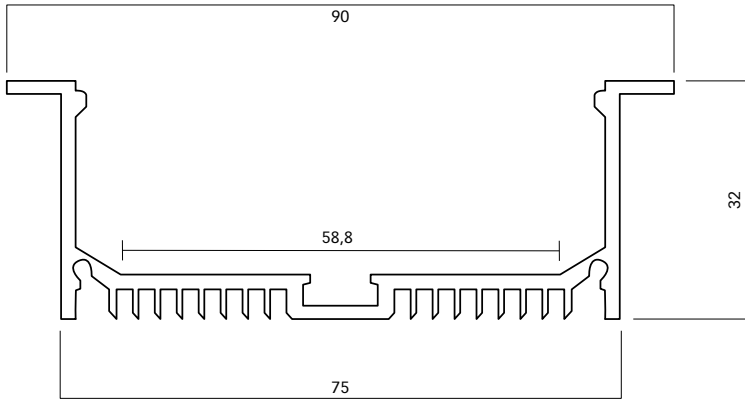

PRF033

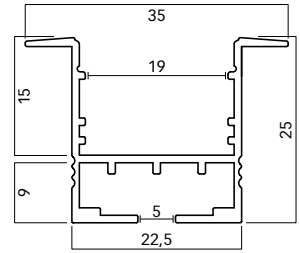

PRF013

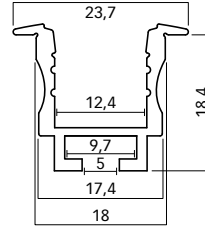

PRF020

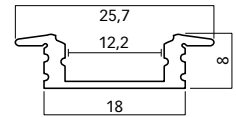

PRF005

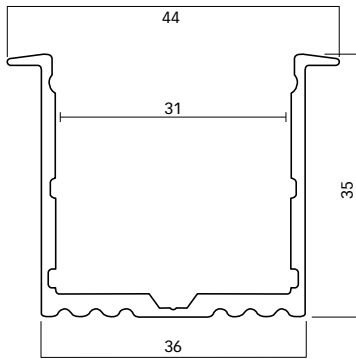

PRF009

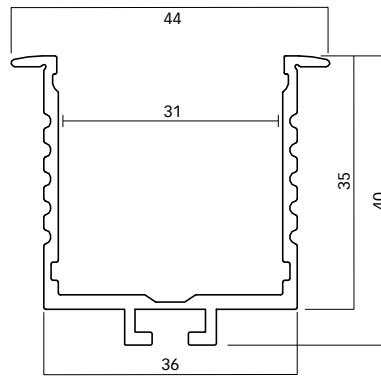

PRF035

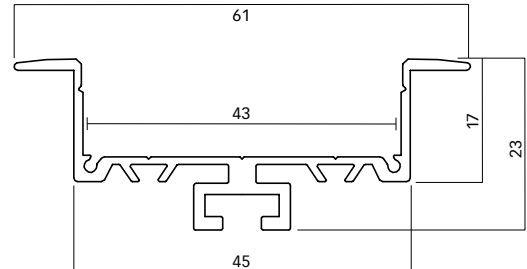

PRF036

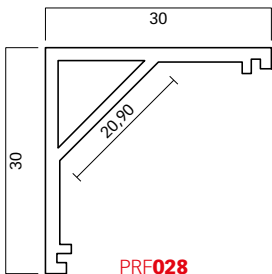

PRF028

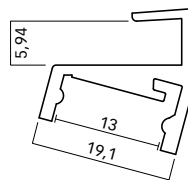

PRF018

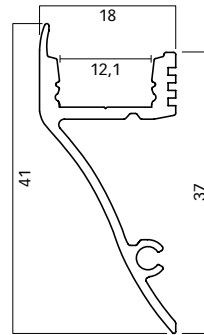

PRF014

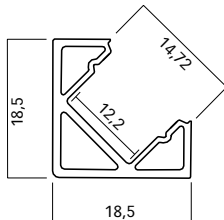

PRF027

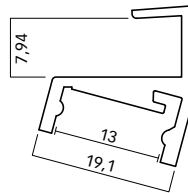

PRF019

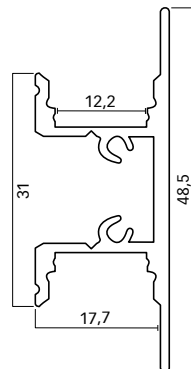

PRF034

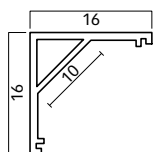

PRF007

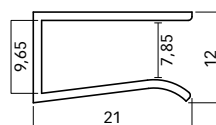

PRF023

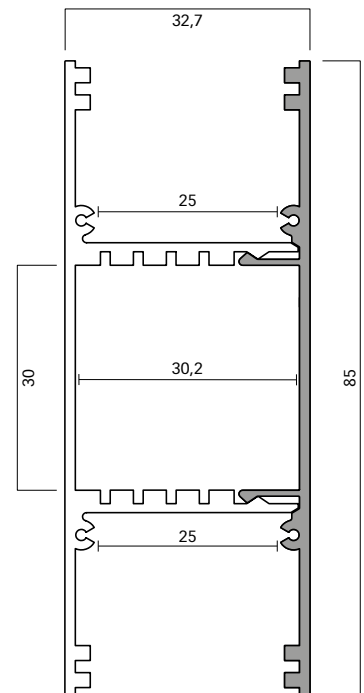

PRF016

SENSOR TOUCH

Circuito elettronico progettato per permettere l'accensione o lo spegnimento di una striscia o di un modulo LED e di regolare l'intensità luminosa tramite un sensore a sfioramento. Le piccole dimensioni permettono l'installazione su profili d'alluminio per strip LED. Alimentazione 12Vdc (il LED blu resterà sempre acceso se il sensore riceverà un'alimentazione in ingresso). Questo prodotto permette il controllo diretto del carico luminoso senza l'ausilio di telecomandi, centraline, pulsanti o trimmer esterni.

S03 - tasto on/off.

S03D - tasto on/off Dimmer.

Electronic circuit designed to allow lighting and shutdown of a LED strip or module and to adjust luminous intensity due to a touch sensor. Small size allow installation in aluminum profiles for LED strips. 12Vdc input power (blue LED will always stay enlightened if sensor is receiving current). This product allow direct control on light intensity without need of any remote control, controller, button or external trimmer.

S03 - on/off button

S03D - on/of Dimmer button

CODE	POWER SUPPLY	POWER/m	IP	CURRENT
S03	12Vdc	60W	IP20	max. 2,5A
S03D	12Vdc	60W	IP20	max. 2,5A

ELENCO CODICI COMPATIBILI PER IL SENSOR TOUCH					
PRF003	PRF004	PRF005	PRF006	PRF007	PRF011
PRF014	PRF015	PRF018	PRF019	PRF020	PRF021
PRF024	PRF025	PRF026	PRF027	PRF029	PRF031

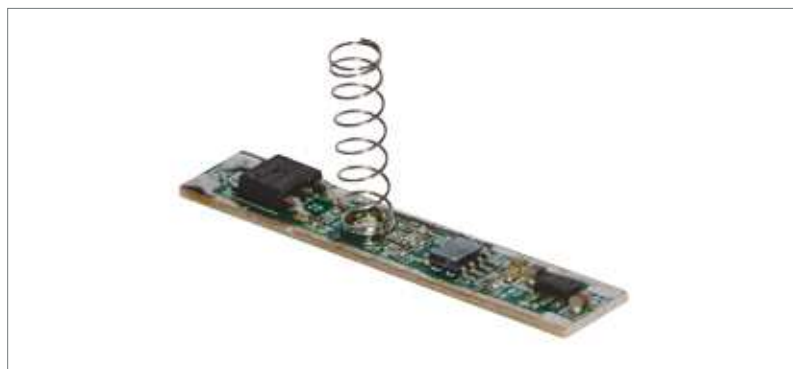

SENSOR TOUCH

LA RESINATURA IP68

Processo attraverso il quale avviene il rivestimento della barra/strip LED con un film sottile di resina in grado di proteggere il prodotto dalle aggressioni esterne. Tramite tale trattamento protettivo, la barra d'illuminazione a LED manterrà inalterata la propria funzionalità e qualità nel tempo, correttamente isolata dall'ambiente esterno e al sicuro da polvere, smog e umidità. La resina utilizzata permette l'impermeabilizzazione del prodotto fino a un grado di protezione IP68 (IP6x protetto completamente contro la penetrazione della polvere - IPx8 protetto contro gli effetti dell'immersione prolungata a profondità superiore a 1m).

Process through which LED bars or strips are coated with a thin layer of resin able to protect product from external aggressions. Through such protective treatment, LED illuminating bar will keep its functionality and quality unaltered in time and will be correctly insulated from external environment and safe from dust, smog and humidity. Used resin allow the waterproofing of the profile up to IP68 protection (i.e. IP6x means completely protected from dust penetration - IPx8 means protected against effects of prolonged immersion to depth higher than 1m).



LA RESINATURA

BARRA LED **su misura**

Dogi Group produce profili in alluminio in varie forme e dimensioni per ogni tipo di esigenza, progettuale. Scegliendo tra i prodotti a catalogo ed inviando la vostra richiesta ai nostri tecnici siamo in grado di formulare un preventivo senza impegno. Il vantaggio è la personalizzazione di qualsiasi particolare, dalla lunghezza del cavo al tipo di fonte luminosa (barra o strip) decidendo la lunghezza della barra.

Dogi Group produces aluminum profiles in many shapes and sizes, suitable for every kind of project requirement. Choosing among products in catalogue and sending your request to our technicians we are able to make a quote without any obligation. Convenience is the customization of any detail, from cable length to the kind of light source (LED bar or strip) deciding also length of profile.

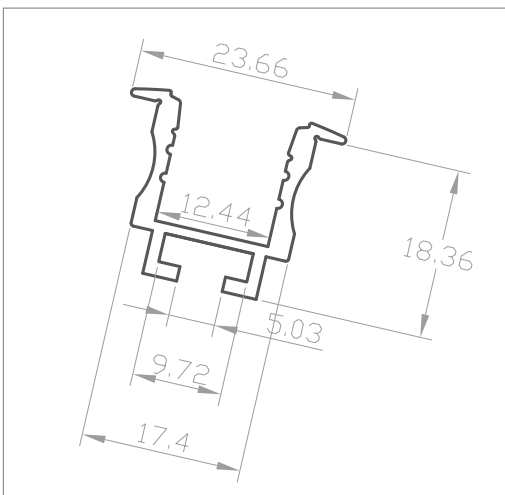

BARRA LED **SU MISURA**

INFO **tecniche**

STRIP

Elenco Strip LED in ordine di efficienza luminosa.

STRIP

Strip LED listed by luminous efficiency.

STRIP

	LED/MT	WATT/MT	LUMEN/MT	LUMEN/W
STP50	60	14,4	1560	108
STP28	60	12	1440	120
STP28/120	120	24	2880	120
STP35	60	4,8	600	125
STP35/120	120	9,6	1200	125
STP35/120s	120	9,6	1200	125
STP35/240	240	19,2	2400	125
STP30	60	6	780	130
STP30/120	120	12	1560	130
STP30/240	240	24	3120	130
PCB202/7	240	15	2760	184
PCB202/15	240	30	6960	232

ALIMENTATORI

Tabella strip LED in ordine di Wattaggio con alimentatore corrispondente.

POWER SUPPLY

Table of strip LED listed by watts with his own power suppliers.

ALIMENTATORI

STRIP W/MT	1MT	2MT	3MT	4MT	5MT
4,8W	APT006.24	APT015.24	APT015.24	APT030.24	APT030.24
6,0W	APT006.24	APT015.24	APT030.24	APT030.24	APT030.24
9,6W	APT015.24	APT030.24	APT030.24	APT060.24	APT060.24
12,0W	APT015.24	APT030.24	APT060.24	APT060.24	APT060.24
14,4W	APT015.24	APT030.24	APT060.24	APT060.24	ALT100.24
15,0W	APT015.24	APT030.24	APT060.24	APT060.24	ALT100.24
19,2W	APT030.24	APT060.24	APT060.24	ALT100.24	ALT100.24
24,0W	APT030.24	APT060.24	ALT100.24	ALT100.24	ALT150.24
30,0W	APT030.24	APT060.24	ALT100.24	ALT150.24	ALT150.24



I disegni, le dimensioni, materiali, colori e finiture presentati in questo catalogo si intendono a titolo indicativo.

Dogi Group si riserva il diritto di modificare i prodotti in qualsiasi momento senza obbligo di preavviso.

I disegni e le foto sono di proprietà di Dogi s.r.l.

È vietato qualsiasi tipo di riproduzione, modifica e duplicazione.

The designs, sizes, materials, colors and finishes shown in this catalog are for information purposes only.

Dogi Group reserves the right to change products at any time without prior notice.

The drawings and the photos are owned by Dogi s.r.l.

Any kind of reproduction, modification, duplication is forbidden.

DOGI s.r.l.

Piazza Dello Sport, 9 - 20015 Parabiago (MI)

Tel. +39 0331 491707 - Fax +39 0331 1817183

info@dogi-group.it - www.dogi-group.it





Dogi GROUP

DOGI s.r.l.

Piazza Dello Sport, 9
20015 Parabiago (MI)
Tel. +39 0331 491707
Fax +30 0331 1817183

info@dogi-group.it
www.dogi-group.it